

BOLBYR®



ROLLER SHUTTERS  
ROLLUIKEN

**BOL ROL 120**  
**BOL ROL 140**

EN

NL

Subject to misprints, errors and technical modifications.  
Drukfouten, fouten en technische wijzigingen voorbehouden.

29770916-240322BOL-ROL-120-140-EN-NL

# Contents

Inhoudsopgave

---

<b>Technical specifications</b>	
Technische specificaties .....	4
<b>Measurements</b>	
Maatvoering .....	5
<b>Scheme</b>	
Schema .....	6
<b>Shortening sizes</b>	
Afkortmaten .....	8
<b>Exploded view</b> .....	12
<b>Bill of material</b>	
Stuklijst .....	11
<b>Parts list</b>	
Onderdelenlijst.....	14

## Technical specifications

Technische specificaties

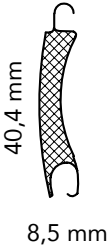
120	
	
Aluminum slat   Gemoffelde aluminium lamel	
Weight armor   Pantsergewicht	: 2,79 [kg/m2]
Cover width   Dekbreedte	: 40,4 [mm]
Thickness slat   Lameldikte	: 8,5 [mm]
Max. surface   Max. oppervlakte	: 9,36 [m2]

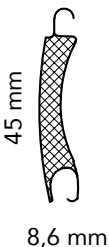
140	
	
Aluminum slat   Gemoffelde aluminium lamel	
Weight armor   Pantsergewicht	: 3 [kg/m2]
Cover width   Dekbreedte	: 45 [mm]
Thickness slat   Lameldikte	: 8,6 [mm]
Max. surface   Max. oppervlakte	: 8 [m2]

## Measurements

Maatvoering

Cross section | Doorsnede  
Sizes | Maten in mm

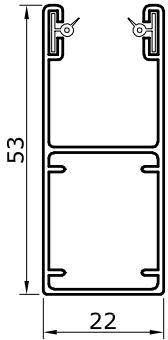

**HTF**

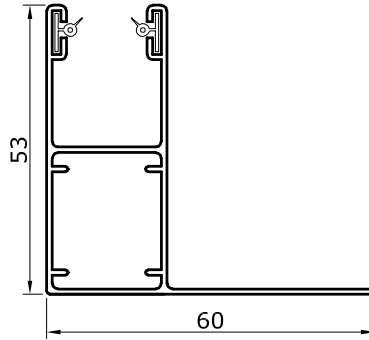

**LHTF**

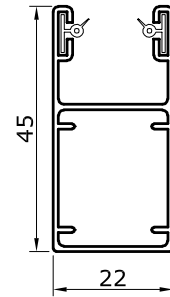

**HF**

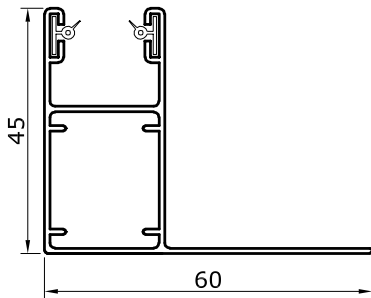

**LHF**

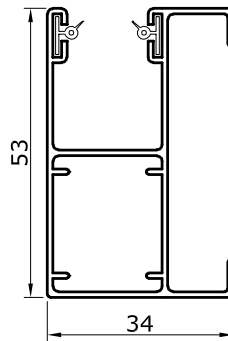

**FHTF/12**

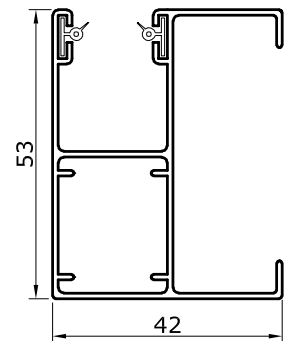

**FHTF/20**

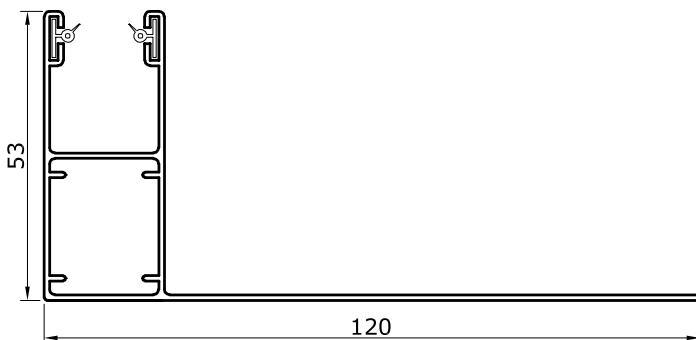

**BLHTF/120**

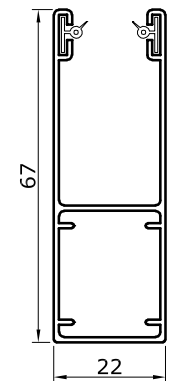

**HTF/67**

## Scheme

Schema

Boxsize   Kapmaat		
Total height Totale hoogte [mm]	BOL ROL 120	BOL ROL 140
1000	137	137
1100		
1200		
1300		
1400		
1500	150	150
1600		
1700		
1800		
1900		
2000	165	165
2100		
2200		
2300		
2400		
2500	180	180
2600		
2700		
2800		
2900		
3000	205	205
3100		
3200		
3300		
3400		
3500	205	205
3600		
3700		
3800		
3900		
4000		

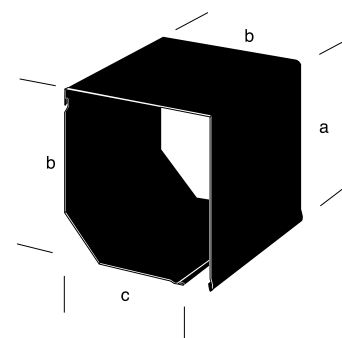

Tabel is op basis van as 8K60

Boxsize   Kapmaat			
Type	Size   Afmeting a in [mm]	Size   Afmeting b in [mm]	Size   Afmeting c in [mm]
137/45°	142	137	105
150/45°	154	150	114
165/45°	169	165	125
180/45°	183	180	147
205/45°	210	205	171

## Scheme

Schema

### BOL ROL 120

Minimal required   
 Minimaal benodigd

Boxsize   Kapmaat [mm]	Heigth guide   Lichthoogte	Total height   Totale hoogte	Width   Breedte [mm] 										
			1000	1100	1200	1300	1400	1500	1600	1700	1800	1900	2000
137	863	1000	6	6	6	6	6	6	6	6	6	6	6
	963	1100	6	6	6	6	6	6	6	6	6	6	6
	1063	1200	6	6	6	6	6	6	6	6	6	6	6
	1163	1300	6	6	6	6	6	6	6	6	6	6	6
	1263	1400	6	6	6	6	6	6	6	6	6	6	6
	1363	1500	6	6	6	6	6	6	6	6	6	6	6
150	1450	1600	6	6	6	6	6	6	6	6	6	6	6
	1550	1700	6	6	6	6	6	6	6	6	6	6	8
	1650	1800	6	6	6	6	6	6	6	6	6	6	8
165	1735	1900	6	6	6	6	6	6	6	6	6	8	10
	1835	2000	6	6	6	6	6	6	6	6	8	10	10
	1935	2100	6	6	6	6	6	6	6	8	10	10	10
	2035	2200	6	6	6	6	6	8	8	10	10	10	10
	2135	2300	6	6	6	6	8	8	10	10	10	15	10
180	2220	2400	6	6	6	8	8	10	10	10	15	15	15
	2320	2500	6	6	8	8	10	10	10	15	15	15	15
	2420	2600	6	6	8	10	10	10	15	15	15	15	15
	2520	2700	6	8	8	10	10	10	15	15	15	15	15
	2620	2800	6	8	10	10	10	10	15	15	15	15	15
	2720	2900	8	8	10	10	10	10	15	15	15	15	15
205	2820	3000	8	8	10	10	15	15	15	15	15	15	15
	2895	3100	8	8	10	10	15	15	15	15	15	15	20
	2995	3200	8	10	10	10	15	15	15	15	15	15	20
	3095	3300	8	10	10	10	15	15	15	15	15	15	20
	3195	3400	10	10	10	15	15	15	15	15	15	15	20
	3295	3500	10	10	10	15	15	15	15	15	15	15	20
	3395	3600	10	10	15	15	15	15	15	15	15	20	20
	3495	3700	10	10	15	15	15	15	15	15	20	20	25
	3595	3800	15	15	15	15	15	15	15	20	20	25	25
	3695	3900	15	15	15	15	15	15	20	20	20	25	25
	3795	4000	15	15	15	15	15	20	20	20	25	25	

## Scheme

Schema

### BOL ROL 120

Boxsize   Kapmaat [mm]	Height guide   Lichthoogte	Total height   Totale hoogte	Width   Breedte [mm]   ↔										
			2100	2200	2300	2400	2500	2600	2700	2800	2900	3000	
137	863	1000	6	6	6	6	6	6	6	6	6	6	6
	963	1100	6	6	6	6	6	6	6	6	6	6	6
	1063	1200	6	6	6	6	6	6	6	6	6	6	6
	1163	1300	6	6	6	6	6	6	8	8	8	8	8
	1263	1400	6	6	6	6	8	8	8	10	10	10	10
	1363	1500	6	6	8	8	8	10	10	10	10	10	10
150	1450	1600	6	6	8	10	10	10	10	10	10	15	15
	1550	1700	8	8	10	10	15	15	15	15	15	15	15
	1650	1800	10	10	10	15	15	15	15	15	15	15	15
165	1735	1900	10	10	15	15	15	15	15	15	15	15	15
	1835	2000	10	15	15	15	15	15	15	15	15	15	15
	1935	2100	10	15	15	15	15	15	15	15	15	15	15
	2035	2200	15	15	15	15	15	15	15	15	15	15	15
	2135	2300	15	15	15	15	15	15	15	15	20	20	20
180	2220	2400	15	15	15	15	15	15	15	20	20	20	20
	2320	2500	15	15	15	15	15	15	20	20	20	20	20
	2420	2600	15	15	15	15	20	20	20	20	20	20	20
	2520	2700	15	15	15	15	20	20	20	20	20	20	20
	2620	2800	15	15	20	20	20	20	20	20	20	25	25
	2720	2900	15	20	20	20	20	20	20	20	25	25	25
205	2820	3000	20	20	20	20	20	20	25	25	25	25	25
	2895	3100	20	20	20	20	20	25	25	25	25	25	25
	2995	3200	20	20	20	20	25	25	25	25	25	25	25
	3095	3300	20	20	20	25	25	25	25	25	25	25	25
	3195	3400	20	20	25	25	25	25	25	25	25	25	25
	3295	3500	20	25	25	25	25	25	25	25	25	25	25
	3395	3600	25	25	25	25	25	25	25	25	25	25	25
	3495	3700	25	25	25	25	25	25	25	25	25	25	25
	3595	3800	25	25	25	25	25	25	25	25	25	25	25
	3695	3900	25	25	25	25	25	25	25	25	25	25	25
3795	4000	25	25	25	25	25	25	25	25	25	25	25	



## Scheme

Schema

### BOL ROL 140





Minimal required  Nm

Boxsize   Kapmaat [mm]	Heigh guide   Lichthoogte	Total height   Totale hoogte	Width   Breedte [mm] ←→													
			1000	1100	1200	1300	1400	1500	1600	1700	1800	1900	2000	2100	2200	2300
137	863	1000	6	6	6	6	6	6	6	6	6	6	6	6	6	6
	963	1100	6	6	6	6	6	6	6	6	6	6	6	6	6	6
	1063	1200	6	6	6	6	6	6	6	6	6	6	6	6	6	6
150	1150	1300	6	6	6	6	6	6	6	6	6	6	6	6	6	6
	1250	1400	6	6	6	6	6	6	6	6	6	6	6	6	6	6
	1350	1500	6	6	6	6	6	6	6	6	6	6	6	6	6	8
165	1435	1600	6	6	6	6	6	6	6	6	6	6	6	6	8	8
	1535	1700	6	6	6	6	6	6	6	6	6	6	8	8	8	10
	1635	1800	6	6	6	6	6	6	6	6	6	8	8	10	10	10
	1735	1900	6	6	6	6	6	6	6	6	8	8	10	10	10	10
	1835	2000	6	6	6	6	6	6	6	6	8	8	10	10	10	15
180	1920	2100	6	6	6	6	6	6	8	8	10	10	10	10	15	15
	2020	2200	6	6	6	6	6	8	8	10	10	10	10	15	15	15
	2120	2300	6	6	6	6	8	8	10	10	10	15	15	15	15	15
	2220	2400	6	6	6	8	8	10	10	10	15	15	15	15	15	15
	2320	2500	6	6	8	8	10	10	10	10	15	15	15	15	15	15
205	2395	2600	6	6	8	10	10	10	10	15	15	15	15	15	15	15
	2495	2700	6	8	8	10	10	10	15	15	15	15	15	15	15	15
	2595	2800	6	8	10	10	10	15	15	15	15	15	15	15	15	20
	2695	2900	8	8	10	10	10	15	15	15	15	15	15	15	20	20
	2795	3000	8	10	10	10	15	15	15	15	15	15	15	15	20	20

Boxsize   Kapmaat [mm]	Heigh guide   Lichthoogte	Total height   Totale hoogte	Width   Breedte [mm]													
			2400	2500	2600	2700	2800	2900	3000	3100	3200	3300	3400	3500	3600	3700
137	863	1000	6	6	6	6	6	6	6	6	6	6	6	6	6	6
	963	1100	6	6	6	6	6	6	6	6	6	8	8	8	8	8
	1063	1200	6	6	6	6	8	8	8	8	8	8	10	10	10	10
150	1150	1300	6	6	8	8	8	8	8	10	10	10	10	10	10	10
	1250	1400	6	8	8	8	8	10	10	10	10	10	10	10	10	10
	1350	1500	8	8	10	10	10	10	10	10	10	15	15	15	15	15
165	1435	1600	10	10	10	10	10	10	15	15	15	15	15	15	15	15
	1535	1700	10	10	10	10	10	15	15	15	15	15	15	15	15	15
	1635	1800	10	10	10	15	15	15	15	15	15	15	15	15	15	15
	1735	1900	10	15	15	15	15	15	15	15	15	15	15	15	15	15
	1835	2000	15	15	15	15	15	15	15	15	15	15	15	20	20	20
180	1920	2100	15	15	15	15	15	15	15	15	15	20	20	20	20	20
	2020	2200	15	15	15	15	15	15	15	20	20	20	20	20	20	20
	2120	2300	15	15	15	15	15	20	20	20	20	20	20	20	20	20
	2220	2400	15	15	15	15	20	20	20	20	20	20	20	20	20	20
	2320	2500	15	15	20	20	20	20	20	20	20	20	20	25	25	25
205	2395	2600	15	20	20	20	20	20	20	20	20	25	25	25	25	25
	2495	2700	20	20	20	20	20	20	20	20	25	25	25	25	25	30
	2595	2800	20	20	20	20	20	20	20	25	25	25	25	25	30	30
	2695	2900	20	20	20	20	20	20	25	25	25	25	25	25	30	30
	2795	3000	20	20	20	20	20	25	25	25	25	25	25	30	30	30

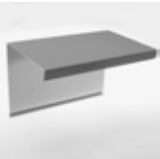
## Shortening sizes

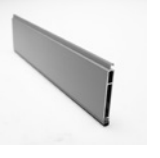
Afkortmaten

Part Onderdeel			
	Slat   Lamel	↔	- 72 mm
	Top cover   Bovenkap	↔	- 6 mm
	Bottom cover   Onderkap	↔	- 6 mm
	Bottom slat   Onderlijst	↔	- 72 mm
	Side guide   Zijgeleider	↕	Depending of boxsize   Afhankelijk van de kapmaat
	Tube   Buis	↔	Depending on the operation type   Afhankelijk van het soort bediening
	8k40 8k60		



## Exploded view

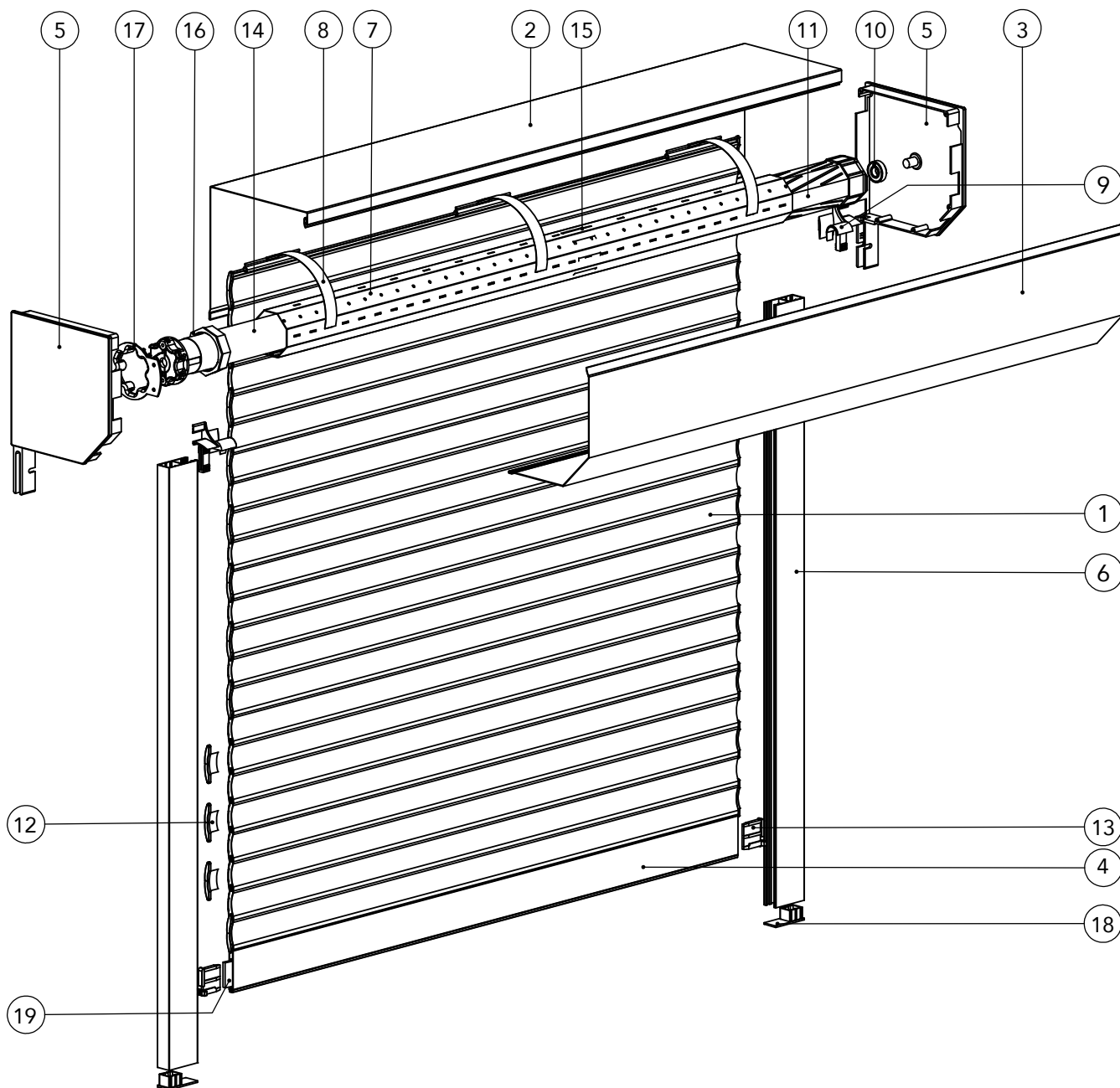

## Bill of material

### Stuklijst

Part Onderdeel	Description Omschrijving	Quantity Hoeveelheid
<b>GENERAL   ALGEMEEN</b>		
1	Slats   Lamellen	Depending on heigth and slat type Afhankelijk van de hoogte en lamel type
2	Top cover   Bovenkap	1
3	Bottom cover   Onderkap	1
4	Bottom slat   Onderlijst	1
5	Side cover   Zijkappen - L+R	1
6	Guide   Zijgeleider	2
7	Tube   Buis	1
8	Springs   Ophangveren	Depending on width Afhankelijk van de breedte
9	Run-ins   Inloopstukken	2
10	Bearing   Kogellager	1 or 2 - Depending on the control Afhankelijk van de bediening
11	Plug   Prop	1 or 2 - Depending on the control Afhankelijk van de bediening
12	Slat guide   Arreteerkap	Depending on number of slats Afhankelijk van het aantal lamellen
13	End stop bottom slat   Eindstop	2
18	End cover   Afsluitdop	2 -Optional
19	Weight bottom slat   Verzwaring onderlijst	Optional
<b>MOTORIZED   ELEKTRISCH</b>		
14	Motor	1
15	Drive   Meenemer	1
16	Crown tube   Adapter buis	1
17	Motorbracket   Motorsteun	1

## Parts list

### Onderdelenlijst

Part Onderdeel	Part No. Art.nr	Description Omschrijving	Length in m' Unit
-------------------	--------------------	-----------------------------	----------------------

#### SLATS | LAMELLEN

1



**BOL ROL 120**

#### **BOL ROL 120 - Slat with slot | Lamel met sleuf**

ART-035732	traffic white   verkeerswit
ART-035733	quartz grey   kwartsgrijs
ART-035747	hell-beige
ART-035748	steel blue   staalblauw
ART-035749	black grey   zwartgrijs
ART-035771	anthracite   antraciet
ART-035791	forest green   bosgroen
ART-035822	natural   naturel
ART-035892	grey   grijs
ART-035893	brown   bruin
ART-035894	cream   crème
ART-035895	beige
ART-035896	ivory   ivoor
ART-035927	white   wit
ART-035587	black   zwart
ART-036239	grey aluminium   grijs aluminium

#### **BOL ROL 120 - Slat without slot | Lamel zonder sleuf**

ART-035730	traffic white   verkeerswit
ART-035731	quartz grey   kwartsgrijs
ART-035744	hell-beige
ART-035745	steel blue   staalblauw
ART-035746	black grey   zwartgrijs
ART-035770	anthracite   antraciet
ART-035790	forest green   bosgroen
ART-035821	natural   naturel
ART-035887	grey   grijs
ART-035888	brown   bruin
ART-035889	cream   crème
ART-035890	beige
ART-035891	ivory   ivoor
ART-035926	white   wit
ART-035586	black   zwart
ART-036238	grey aluminium   grijs aluminium

## Parts list

### Onderdelenlijst

Part Onderdeel	Part No. Art.nr	Description Omschrijving	Length in m' Unit
-------------------	--------------------	-----------------------------	----------------------

#### SLATS | LAMELLEN



#### **BOL ROL 140 - Slat with slot | Lamel met sleuf**

ART-037681	traffic white   verkeerswit
ART-037682	quartz grey   kwartsgrijs
ART-037686	hell-beige
ART-037687	steel blue   staalblauw
ART-037688	black grey   zwartgrijs
ART-037690	anthracite   antraciet
ART-037692	forest green   bosgroen
ART-037694	natural   naturel
ART-037700	grey   grijs
ART-037701	brown   bruin
ART-037702	cream   crème
ART-037703	beige
ART-037704	ivory   ivoor
ART-037706	white   wit
ART-037678	black   zwart

#### **BOL ROL 140 - Slat without slot | Lamel zonder sleuf**

ART-037679	traffic white   verkeerswit
ART-037680	quartz grey   kwartsgrijs
ART-037683	hell-beige
ART-037684	steel blue   staalblauw
ART-037685	black grey   zwartgrijs
ART-037689	anthracite   antraciet
ART-037691	forest green   bosgroen
ART-037693	natural   naturel
ART-037695	grey   grijs
ART-037696	brown   bruin
ART-037697	cream   crème
ART-037698	beige
ART-037699	ivory   ivoor
ART-037705	white   wit
ART-037677	black   zwart

## Parts list

### Onderdelenlijst

Part Onderdeel	Part No. Art.nr	Description Omschrijving	Length in m' Unit
-------------------	--------------------	-----------------------------	----------------------

#### SLAT GUIDES | ARRETEERKAPPEN

12



ART-036206 **BOL ROL 120 - Slat guide | Arreteerkap**

ART-036205 **BOL ROL 140 - Slat guide | Arreteerkap**

#### TOP COVERS | BOVENKAPPEN

2

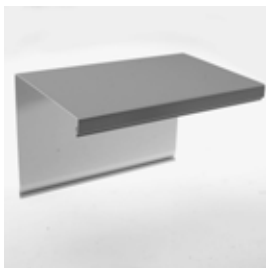

##### Top cover 137 | Bovenkap 137

ART-035830 traffic white | verkeerswit  
 ART-035831 quartz grey | kwartsgrijs  
 ART-035857 hell-beige  
 ART-035858 steel blue | staalblauw  
 ART-035859 black/grey | zwartgrijs  
 ART-035903 anthracite | antraciet  
 ART-035914 forest green | bosgroen  
 ART-035953 natural | naturel  
 ART-035970 grey | grijs  
 ART-035971 brown | bruin  
 ART-035972 cream | crème  
 ART-035974 ivory | ivoor  
 ART-036025 white | wit  
 ART-035588 anthracite textured paint | antraciet structuurlak  
 ART-035618 black textured paint | zwart structuurlak

##### Top cover 150 | Bovenkap 150

ART-035834 traffic white | verkeerswit  
 ART-035835 quartz grey | kwartsgrijs  
 ART-035863 hell-beige  
 ART-035864 steel blue | staalblauw  
 ART-035865 black/grey | zwartgrijs  
 ART-035905 anthracite | antraciet  
 ART-035916 forest green | bosgroen  
 ART-035955 natural | naturel  
 ART-035980 grey | grijs  
 ART-035981 brown | bruin  
 ART-035982 cream | crème  
 ART-035984 ivory | ivoor  
 ART-036027 white | wit  
 ART-035590 anthracite textured paint | antraciet structuurlak  
 ART-035620 black textured paint | zwart structuurlak



## Parts list

### Onderdelenlijst

Part Onderdeel	Part No. Art.nr	Description Omschrijving	Length in m' Unit
-------------------	--------------------	-----------------------------	----------------------

#### TOP COVERS | BOVENKAPPEN

2



#### Top cover 165 | Bovenkap 165

ART-035838	traffic white   verkeerswit
ART-035839	quartz grey   kwartsgrijs
ART-035869	hell-beige
ART-035870	steel blue   staalblauw
ART-035871	black/grey   zwartgrijs
ART-035907	anthracite   antraciet
ART-035918	forest green   bosgroen
ART-035957	natural   naturel
ART-035990	grey   grijs
ART-035991	brown   bruin
ART-035992	cream   crème
ART-035994	ivory   ivoor
ART-036029	white   wit
ART-035592	anthracite textured paint   antraciet structuurlak
ART-035622	black textured paint   zwart structuurlak

#### Top cover 180 | Bovenkap 180

ART-035842	traffic white   verkeerswit
ART-035843	quartz grey   kwartsgrijs
ART-035875	hell-beige
ART-035876	steel blue   staalblauw
ART-035877	black/grey   zwartgrijs
ART-035909	anthracite   antraciet
ART-035920	forest green   bosgroen
ART-035959	natural   naturel
ART-036000	grey   grijs
ART-036001	brown   bruin
ART-036002	cream   crème
ART-036004	ivory   ivoor
ART-036031	white   wit
ART-035594	anthracite textured paint   antraciet structuurlak
ART-035624	black textured paint   zwart structuurlak

#### Top cover 205 | Bovenkap 205

ART-035846	traffic white   verkeerswit
ART-035847	quartz grey   kwartsgrijs
ART-035881	hell-beige
ART-035882	steel blue   staalblauw
ART-035883	black/grey   zwartgrijs
ART-035911	anthracite   antraciet
ART-035922	forest green   bosgroen
ART-035961	natural   naturel
ART-036010	grey   grijs
ART-036011	brown   bruin
ART-036012	cream   crème
ART-036014	ivory   ivoor
ART-036033	white   wit
ART-035596	anthracite textured paint   antraciet structuurlak
ART-035626	black textured paint   zwart structuurlak

## Parts list

### Onderdelenlijst

Part Onderdeel	Part No. Art.nr	Description Omschrijving	Length in m' Unit
-------------------	--------------------	-----------------------------	----------------------

#### BOTTOM COVERS | ONDERKAPPEN

3

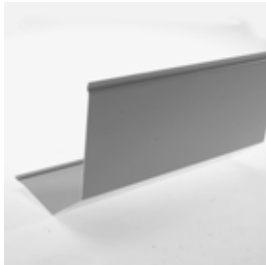

#### Bottom cover 137 | Onderkap 137

ART-035832	traffic white   verkeerswit
ART-035833	quartz grey   kwartsgrijs
ART-035860	hell-beige
ART-035861	steel blue   staalblauw
ART-035862	black/grey   zwartgrijs
ART-035904	anthracite   antraciet
ART-035915	forest green   bosgroen
ART-035954	natural   naturel
ART-035975	grey   grijs
ART-035976	brown   bruin
ART-035977	cream   crème
ART-035979	ivory   ivoor
ART-036026	white   wit
ART-035589	anthracite textured paint   antraciet structuurlak
ART-035619	black textured paint   zwart structuurlak

#### Bottom cover 150 | Onderkap 150

ART-035836	traffic white   verkeerswit
ART-035837	quartz grey   kwartsgrijs
ART-035866	hell-beige
ART-035867	steel blue   staalblauw
ART-035868	black/grey   zwartgrijs
ART-035906	anthracite   antraciet
ART-035917	forest green   bosgroen
ART-035956	natural   naturel
ART-035985	grey   grijs
ART-035986	brown   bruin
ART-035987	cream   crème
ART-035989	ivory   ivoor
ART-036028	white   wit
ART-035591	anthracite textured paint   antraciet structuurlak
ART-035621	black textured paint   zwart structuurlak

#### Bottom cover 165 | Onderkap 165

ART-035840	traffic white   verkeerswit
ART-035841	quartz grey   kwartsgrijs
ART-035872	hell-beige
ART-035873	steel blue   staalblauw
ART-035874	black/grey   zwartgrijs
ART-035908	anthracite   antraciet
ART-035919	forest green   bosgroen
ART-035958	natural   naturel
ART-035995	grey   grijs
ART-035996	brown   bruin
ART-035997	cream   crème
ART-035999	ivory   ivoor
ART-036030	white   wit
ART-035593	anthracite textured paint   antraciet structuurlak
ART-035623	black textured paint   zwart structuurlak

## Parts list

### Onderdelenlijst

Part Onderdeel	Part No. Art.nr	Description Omschrijving	Length in m' Unit
-------------------	--------------------	-----------------------------	----------------------

#### BOTTOM COVERS | ONDERKAPPEN

3

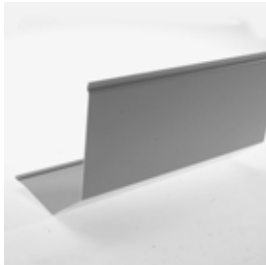

##### Bottom cover 180 | Onderkap 180

ART-035844	traffic white   verkeerswit
ART-035845	quartz grey   kwartsgrijs
ART-035878	hell-beige
ART-035879	steel blue   staalblauw
ART-035880	black/grey   zwartgrijs
ART-035910	anthracite   antraciet
ART-035921	forest green   bosgroen
ART-035960	natural   naturel
ART-036005	grey   grijs
ART-036006	brown   bruin
ART-036007	cream   crème
ART-036009	ivory   ivoor
ART-036032	white   wit
ART-035595	anthracite textured paint   antraciet structuurlak
ART-035625	black textured paint   zwart structuurlak

##### Bottom cover 205 | Onderkap 205

ART-035848	traffic white   verkeerswit
ART-035849	quartz grey   kwartsgrijs
ART-035884	hell-beige
ART-035885	steel blue   staalblauw
ART-035886	black/grey   zwartgrijs
ART-035912	anthracite   antraciet
ART-035923	forest green   bosgroen
ART-035962	natural   naturel
ART-036015	grey   grijs
ART-036016	brown   bruin
ART-036017	cream   crème
ART-036019	ivory   ivoor
ART-036034	white   wit
ART-035597	anthracite textured paint   antraciet structuurlak
ART-035627	black textured paint   zwart structuurlak

#### BOTTOM SLATS | ONDERLIJSTEN

4



##### Bottom slat with rubber | Onderlijst met rubber

ART-035663	traffic white   verkeerswit
ART-035664	quartz grey   kwartsgrijs
ART-035681	hell-beige
ART-035682	steel blue   staalblauw
ART-035683	black/grey   zwartgrijs
ART-035695	anthracite   antraciet
ART-035703	forest green   bosgroen
ART-035729	natural   naturel
ART-035761	grey   grijs
ART-035762	brown   bruin
ART-035763	cream   crème
ART-035765	ivory   ivoor
ART-035803	white   wit
ART-035767	anthracite textured paint   antraciet structuurlak
ART-035766	black textured paint   zwart structuurlak

## Parts list

### Onderdelenlijst

Part Onderdeel	Part No. Art.nr	Description Omschrijving	Length in m' Unit
-------------------	--------------------	-----------------------------	----------------------

#### SIDE COVERS | ZIJKAPPEN

5

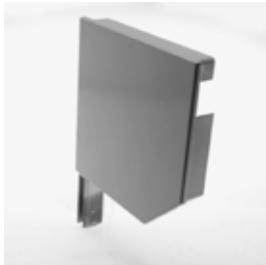

#### Side cover 137 | Zijkap 137 - L+R

ART-035780	traffic white   verkeerswit
ART-035781	quartz grey   kwartsgrijs
ART-035804	hell-beige
ART-035805	steel blue   staalblauw
ART-035806	black/grey   zwartgrijs
ART-035825	anthracite   antraciet
ART-035852	forest green   bosgroen
ART-035898	natural   naturel
ART-035928	grey   grijs
ART-035929	brown   bruin
ART-035930	cream   crème
ART-035932	ivory   ivoor
ART-035965	white   wit
ART-035581	anthracite textured paint   antraciet structuurlak
ART-035607	black textured paint   zwart structuurlak

#### Side cover 150 | Zijkap 150 - L+R

ART-035782	traffic white   verkeerswit
ART-035783	quartz grey   kwartsgrijs
ART-035807	hell-beige
ART-035808	steel blue   staalblauw
ART-035809	black/grey   zwartgrijs
ART-035826	anthracite   antraciet
ART-035853	forest green   bosgroen
ART-035899	natural   naturel
ART-035933	grey   grijs
ART-035934	brown   bruin
ART-035935	cream   crème
ART-035937	ivory   ivoor
ART-035966	white   wit
ART-035582	anthracite textured paint   antraciet structuurlak
ART-035608	black textured paint   zwart structuurlak

#### Side cover 165 | Zijkap 165 - L+R

ART-035784	traffic white   verkeerswit
ART-035785	quartz grey   kwartsgrijs
ART-035810	hell-beige
ART-035811	steel blue   staalblauw
ART-035812	black/grey   zwartgrijs
ART-035827	anthracite   antraciet
ART-035854	forest green   bosgroen
ART-035900	natural   naturel
ART-035938	grey   grijs
ART-035939	brown   bruin
ART-035940	cream   crème
ART-035942	ivory   ivoor
ART-035967	white   wit
ART-035583	anthracite textured paint   antraciet structuurlak
ART-035609	black textured paint   zwart structuurlak

## Parts list

### Onderdelenlijst

Part Onderdeel	Part No. Art.nr	Description Omschrijving	Length in m' Unit
-------------------	--------------------	-----------------------------	----------------------

#### SIDE COVERS | ZIJKAPPEN

5

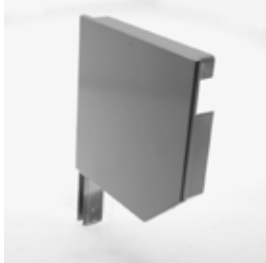

#### Side cover 180 | Zijkap 180 - L+R

ART-035786	traffic white   verkeerswit
ART-035787	quartz grey   kwartsgrijs
ART-035813	hell-beige
ART-035814	steel blue   staalblauw
ART-035815	black/grey   zwartgrijs
ART-035828	anthracite   antraciet
ART-035855	forest green   bosgroen
ART-035901	natural   naturel
ART-035943	grey   grijs
ART-035944	brown   bruin
ART-035945	cream   crème
ART-035947	ivory   ivoor
ART-035968	white   wit
ART-035584	anthracite textured paint   antraciet structuurlak
ART-035610	black textured paint   zwart structuurlak

#### Side cover 205 | Zijkap 205 - L+R

ART-035788	traffic white   verkeerswit
ART-035789	quartz grey   kwartsgrijs
ART-035816	hell-beige
ART-035817	steel blue   staalblauw
ART-035818	black/grey   zwartgrijs
ART-035829	anthracite   antraciet
ART-035856	forest green   bosgroen
ART-035902	natural   naturel
ART-035948	grey   grijs
ART-035949	brown   bruin
ART-035950	cream   crème
ART-035952	ivory   ivoor
ART-035969	white   wit
ART-035585	anthracite textured paint   antraciet structuurlak
ART-035611	black textured paint   zwart structuurlak

#### COVER PLATES | AFDEKPLATEN

ART-019234 **Coverplate 150, hole 72 | Afdekplaat 150, gat 72**

ART-000101 **Coverplate 165, hole 72 | Afdekplaat 165, gat 72**

ART-019235 **Coverplate 180, hole 72 | Afdekplaat 180, gat 72**

ART-000103 **Coverplate 205, hole 72 | Afdekplaat 205, gat 72**

## Parts list

Onderdelenlijst

Part Onderdeel	Part No. Art.nr	Description Omschrijving	Length in m' Unit
-------------------	--------------------	-----------------------------	----------------------

### CENTRE COVER SUPPORTS | MIDDEN KAPSTEUNEN



ART-000059 **Centre cover support | Middenkapsteun 150  
buffed edge | afgeslepen rand**

ART-000072 **Centre cover support | Middenkapsteun 165  
buffed edge | afgeslepen rand**

ART-000084 **Centre cover support | Middenkapsteun 180  
buffed edge | afgeslepen rand**

ART-000096 **Centre cover support | Middenkapsteun 205  
buffed edge | afgeslepen rand**

## Parts list

### Onderdelenlijst

Part Onderdeel	Part No. Art.nr	Description Omschrijving	Length in m' Unit
-------------------	--------------------	-----------------------------	----------------------

#### GUIDES | ZIJGELEIDERS

6

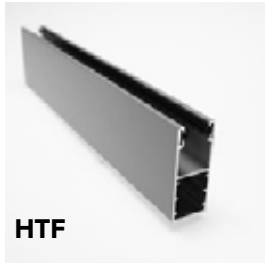

<b>Guide   Zijgeleider - HTF - BOL ROL 120 - BOL ROL 140</b>	
ART-035648	traffic white   verkeerswit
ART-035649	quartz grey   kwartsgrijs
ART-035665	hell-beige
ART-035666	steel blue   staalblauw
ART-035667	black/grey   zwartgrijs
ART-035684	anthracite   antraciet
ART-035696	forest green   bosgroen
ART-035704	natural   naturel
ART-035750	grey   grijs
ART-035751	brown   bruin
ART-035752	cream   crème
ART-035754	ivory   ivoor
ART-035792	white   wit
ART-035756	anthracite textured paint   antraciet structuurlak
ART-035755	black textured paint   zwart structuurlak



<b>Guide + Brushes   Zijgeleider + Borstel - HTF - BOL ROL 120 - BOL ROL 140</b>	
ART-040420	traffic white   verkeerswit
ART-040421	quartz grey   kwartsgrijs
ART-040423	hell-beige
ART-040424	steel blue   staalblauw
ART-040425	black grey   zwartgrijs
ART-040427	anthracite   antraciet
ART-040429	forest green   bosgroen
ART-040430	natural   naturel
ART-040437	grey   grijs
ART-040438	brown   bruin
ART-040439	cream   crème
ART-040440	ivory   ivoor
ART-040444	white   wit
ART-040441	black textured paint   zwart structuurlak
ART-040442	anthracite textured paint   antraciet structuurlak



<b>Guide LHTF   Zijgeleider LHTF - BOL ROL 120 - BOL ROL 140</b>	
ART-035628	traffic white   verkeerswit
ART-035629	quartz grey   kwartsgrijs
ART-035636	hell-beige
ART-035637	steel blue   staalblauw
ART-035638	black/grey   zwartgrijs
ART-035650	anthracite   antraciet
ART-035668	forest green   bosgroen
ART-035685	natural   naturel
ART-035705	grey   grijs
ART-035706	brown   bruin
ART-035707	cream   crème
ART-035709	ivory   ivoor
ART-035757	white   wit
ART-035711	anthracite textured paint   antraciet structuurlak
ART-035710	black textured paint   zwart structuurlak

## Parts list

### Onderdelenlijst

Part Onderdeel	Part No. Art.nr	Description Omschrijving	Length in m' Unit
-------------------	--------------------	-----------------------------	----------------------

#### GUIDES | ZIJGELEIDERS

6



**LHTF +  
brush | borstel**

Part No. Art.nr	Description Omschrijving
ART-040415	traffic white   verkeerswit
ART-040416	quartz grey   kwartsgrijs
ART-040417	hell-beige
ART-040418	steel blue   staalblauw
ART-040419	black grey   zwartgrijs
ART-040422	anthracite   antraciet
ART-040426	forest green   bosgroen
ART-040428	natural   naturel
ART-040431	grey   grijs
ART-040432	brown   bruin
ART-040433	cream   crème
ART-040434	ivory   ivoor
ART-040443	white   wit
ART-040436	anthracite textured paint   antraciet structuurlak
ART-040435	black textured paint   zwart structuurlak

#### **Guide + Brushes | Zijgeleider + Borstel - LHTF - BOL ROL 120 - BOL ROL 140**

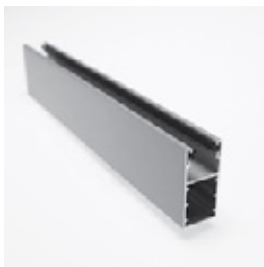

Part No. Art.nr	Description Omschrijving
ART-035669	traffic white   verkeerswit
ART-035670	quartz grey   kwartsgrijs
ART-035686	hell-beige
ART-035687	steel blue   staalblauw
ART-035688	black/grey   zwartgrijs
ART-035697	anthracite   antraciet
ART-035712	forest green   bosgroen
ART-035734	natural   naturel
ART-035772	grey   grijs
ART-035773	brown   bruin
ART-035774	cream   crème
ART-035776	ivory   ivoor
ART-035823	white   wit
ART-035778	anthracite textured paint   antraciet structuurlak
ART-035777	black textured paint   zwart structuurlak

#### **Guide | Zijgeleider - HF - BOL ROL 120 - BOL ROL 140**



**MHTF**

Part No. Art.nr	Description Omschrijving
ART-035689	traffic white   verkeerswit
ART-035690	quartz grey   kwartsgrijs
ART-035698	hell-beige
ART-035699	steel blue   staalblauw
ART-035700	black grey   zwartgrijs
ART-035713	anthracite   antraciet
ART-035735	forest green   bosgroen
ART-035758	natural   naturel
ART-035794	grey   grijs
ART-035795	brown   bruin
ART-035796	cream   crème
ART-035798	ivory   ivoor
ART-035851	white   wit
ART-035800	anthracite textured paint   antraciet structuurlak
ART-035799	black textured paint   zwart structuurlak

#### **Centre guide | Middengeleider - MHTf**



## Parts list

### Onderdelenlijst

Part Onderdeel	Part No. Art.nr	Description Omschrijving	Length in m' Unit
-------------------	--------------------	-----------------------------	----------------------

#### GUIDES | ZIJGELEIDERS

6



<b>Guide   Zijgeleider - LHF - BOL ROL 120 - BOL ROL 140</b>	
ART-035639	traffic white   verkeerswit
ART-035640	quartz grey   kwartsgrijs
ART-035651	hell-beige
ART-035652	steel blue   staalblauw
ART-035653	black/grey   zwartgrijs
ART-035671	anthracite   antraciet
ART-035691	forest green   bosgroen
ART-035701	natural   naturel
ART-035736	grey   grijs
ART-035737	brown   bruin
ART-035738	cream   crème
ART-035740	ivory   ivoor
ART-035779	white   wit
ART-035742	anthracite textured paint   antraciet structuurlak
ART-035741	black textured paint   zwart structuurlak



<b>Guide   Zijgeleider - FHTF/12 - BOL ROL 120 - BOL ROL 140</b>	
ART-035630	traffic white   verkeerswit
ART-035631	quartz grey   kwartsgrijs
ART-035641	hell-beige
ART-035642	steel blue   staalblauw
ART-035643	black/grey   zwartgrijs
ART-035654	anthracite   antraciet
ART-035672	forest green   bosgroen
ART-035692	natural   naturel
ART-035714	grey   grijs
ART-035715	brown   bruin
ART-035716	cream   crème
ART-035718	ivory   ivoor
ART-035759	white   wit
ART-035720	anthracite textured paint   antraciet structuurlak
ART-035719	black textured paint   zwart structuurlak



<b>Guide   Zijgeleider - FHTF/20 - BOL ROL 120 - BOL ROL 140</b>	
ART-035598	traffic white   verkeerswit
ART-035599	quartz grey   kwartsgrijs
ART-035602	hell-beige
ART-035603	steel blue   staalblauw
ART-035604	black/grey   zwartgrijs
ART-035612	anthracite   antraciet
ART-035616	forest green   bosgroen
ART-035632	natural   naturel
ART-035655	grey   grijs
ART-035656	brown   bruin
ART-035657	cream   crème
ART-035659	ivory   ivoor
ART-035693	white   wit
ART-035661	anthracite textured paint   antraciet structuurlak
ART-035660	black textured paint   zwart structuurlak

## Parts list

### Onderdelenlijst

Part Onderdeel	Part No. Art.nr	Description Omschrijving	Length in m' Unit
-------------------	--------------------	-----------------------------	----------------------

#### GUIDES | ZIJGELEIDERS

##### BLHTF

<b>Guide   Zijgeleider - BLHTF - BOL ROL 120 - BOL ROL 140</b>	
ART-035605	traffic white   verkeerswit
ART-035606	quartz grey   kwartsgrijs
ART-035613	hell-beige
ART-035614	steel blue   staalblauw
ART-035615	black/grey   zwartgrijs
ART-035617	anthracite   antraciet
ART-035633	forest green   bosgroen
ART-035644	natural   naturel
ART-035673	grey   grijs
ART-035674	brown   bruin
ART-035675	cream   crème
ART-035677	ivory   ivoor
ART-035702	white   wit
ART-035679	anthracite textured paint   antraciet structuurlak
ART-035678	black textured paint   zwart structuurlak

##### HTF/67

<b>Guide   Zijgeleider - HTF/67 - BOL ROL 120 - BOL ROL 140</b>	
ART-035634	traffic white   verkeerswit
ART-035635	quartz grey   kwartsgrijs
ART-035645	hell-beige
ART-035646	steel blue   staalblauw
ART-035647	black/grey   zwartgrijs
ART-035662	anthracite   antraciet
ART-035680	forest green   bosgroen
ART-035694	natural   naturel
ART-035722	grey   grijs
ART-035723	brown   bruin
ART-035724	cream   crème
ART-035726	ivory   ivoor
ART-035760	white   wit
ART-035728	anthracite textured paint   antraciet structuurlak
ART-035727	black textured paint   zwart structuurlak

18

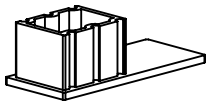

<b>End cover guide   Afsluitdop geleider</b>	
ART-000261	white   wit
ART-000262	grey   grijs
ART-000263	brown   bruin
ART-000264	hell-beige
ART-000265	cream   crème
ART-000266	black   zwart
ART-000267	dark green   donkergroen
ART-000268	steel blue   staalblauw
ART-000269	anthracite   antraciet
ART-000270	ivory   ivoor

## Parts list

### Onderdelenlijst

Part Onderdeel	Part No. Art.nr	Description Omschrijving	Length in m' Unit
-------------------	--------------------	-----------------------------	----------------------

#### CORNER PROFILES | HOEKPROFIELEN

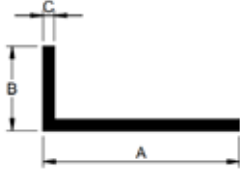

#### Corner profile | Hoekprofiel 30x20x2

ART-000397	white   wit (9016)
ART-000398	grey   grijs
ART-000399	brown   bruin
ART-000400	hell-beige
ART-000401	natural   naturel
ART-000402	cream   crème
ART-000403	red   rood
ART-000404	black   zwart
ART-000405	dark green   donkergroen
ART-000406	blue   blauw (5011)
ART-000407	anthracite grey   antracietgrijs (7016)
ART-000408	ivory   ivoor
ART-000409	anthracite textured paint   antraciet structuurlak - VS716

#### Corner profile | Hoekprofiel 70x20x2

ART-000410	white   wit (9016)
ART-000411	grey   grijs
ART-000412	brown   bruin
ART-000413	hell-beige
ART-000414	natural   naturel
ART-000415	cream   crème
ART-000416	red   rood
ART-000417	black   zwart
ART-000418	dark green   donkergroen
ART-000419	blue   blauw (5011)
ART-000420	anthracite grey   antracietgrijs (7016)
ART-000421	ivory   ivoor
ART-000422	anthracite textured paint   antraciet structuurlak - VS716

#### Corner profile | Hoekprofiel 70x30x2



ART-000423	white   wit (9010)
ART-000424	ivory   ivoor

#### Corner profile | Hoekprofiel 70x40x2

ART-000425	white   wit
ART-000426	grey   grijs
ART-000427	brown   bruin
ART-000428	hell-beige
ART-000429	dark green   donkergroen
ART-000430	ivory   ivoor

## Parts list

### Onderdelenlijst

Part Onderdeel	Part No. Art.nr	Description Omschrijving	Length in m' Unit	
<b>TUBES AND ACCESSORIES   STALEN BUIZEN EN TOEBEHOREN</b>				
7		ART-001209	Steel tube   Stalen buis 8K40 X 0,8 mm	6,0 m <sup>1</sup>
		ART-001210	Steel tube   Stalen buis 8K60 x 0,9 mm	6,0 m <sup>1</sup>
19		<b>Weight bottom slat   Verzwarengstrip onderlijst galvanised   verzinkt - 25x3 mm 2,5 m</b>		
		ART-000366	500 mm	
		ART-000367	750 mm	
ART-000368	1000 mm			
		ART-000292	Filler ring 8K60 Ø80   Opvulring 8K60 naar Ø80	
<b>SPRINGS   OPHANGVEREN</b>				
8		ART-000298	Spring   Ophangveer - 13 cm	
		ART-000300	Spring   Ophangveer - 17 cm	
		ART-000302	Spring   Ophangveer - 19 cm	
<b>CAPS AND STOPS   DOPPEN EN STOPPEN</b>				
13		ART-000259	End stop bottom slat - Fixed   Eindstop onderlijst - Vast	
		ART-000260	End stop bottom slat - Rotatable Eindstop onderlijst - Draaibaar	
		<b>Cover caps   Bol Afdekdopje 10 mm - 8 stuks</b> ART-000241 white   wit ART-000242 grey   grijs ART-000243 brown   bruin ART-000244 hell-beige ART-000245 natural   naturel ART-000246 cream   crème ART-000247 red   rood ART-000248 black   zwart ART-000249 dark green   donkergroen ART-000250 steel blue   staalblauw ART-000251 anthracite   antracietgrijs ART-000252 ivory   ivoor (9001) ART-032191 quartz grey   kwartsgrijs ART-032192 black grey   zwartgrijs ART-032193 umbre grey   ombergrijs		

## Parts list

### Onderdelenlijst

Part Onderdeel	Part No. Art.nr	Description Omschrijving	Length in m' Unit
-------------------	--------------------	-----------------------------	----------------------

#### RUN-INS | INLOOPSTUKKEN

9

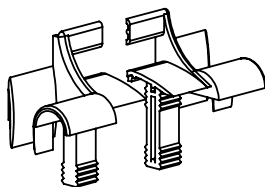

Part No. Art.nr	Description Omschrijving
ART-036258	Run-in   Inloopstuk white   wit
ART-036260	ivory   ivoor
ART-036262	black   zwart

Part No. Art.nr	Description Omschrijving
ART-036259	Run-in small   Inloopstuk smal white   wit
ART-036261	ivory   ivoor
ART-036263	black   zwart

#### PLUGS AND DISCS | ASPROPPEN EN SCHIJVEN



ART-000283	Plug with spring 8K40/60 for bearing 28 incl. clip Prop verend 8K40/60 voor lager 28 incl. clip
------------	--

ART-000281	Adjustable plug 8K40 for bearing 28 mm Verstelbare prop 8K40 voor lager 28 mm
------------	--



ART-000287	Tape disc 125 Tube   Bandschijf 125 Buis 8K40 & 8K60
------------	--

ART-028233	Tape disc 135 Tube   Bandschijf 135 Buis 8K40 & 8K60
------------	--

ART-000289	Tape disc 155 Tube   Bandschijf 155 Buis 8K40 & 8K60
------------	--

ART-000290	Tape disc 175 Tube   Bandschijf 170 Buis 8K40 & 8K60
------------	--

ART-000291	Tape disc 190 Tube   Bandschijf 190 mm 8K40/50/60
------------	---



ART-000295	Mounting plate with axle   Bevestigingsplaat met as 12 mm
------------	---

## Parts list

### Onderdelenlijst

Part Onderdeel	Part No. Art.nr	Description Omschrijving	Length in m' Unit
-------------------	--------------------	-----------------------------	----------------------

#### DECELERATORS / REDUCTION | VERTRAGERS / REDUCTIE



ART-000316 **Strap disc with decelerator | Bandschijf met vertrager**  
**140 mm 1:3**  
 Tensile strength 35 kg - box 165 | Trekkkracht 35 kg - kast 165

ART-000317 **Strap disc with decelerator | Bandschijf met vertrager**  
**160 mm 1:3**  
 Tensile strength 35 kg - box 180 | Trekkkracht 35 kg - kast 180

ART-000318 **Strap disc with decelerator | Bandschijf met vertrager**  
**180 mm 1:3**  
 Tensile strength 35 kg - box 205 | Trekkkracht 35 kg - kast 205



ART-000311 **Axle plug 8K40 aluminium for decelerator**  
**Asprop 8K40 aluminium t.b.v. vertrager**

ART-000312 **Axle plug 8K60 aluminium for decelerator**  
**Asprop 8K60 aluminium t.b.v. vertrager**

#### BEARINGS AND BEARING HOLDERS | LAGERS EN LAGERHOUDERS

10



ART-033324 **Bearing | Groefkogellager 28 mm**

#### STRAP WINDERS | BANDOPWINDERS







ART-000319 **Strap winder hinged | Bandopwinder scharnierend**  
**(4.5 m strap | band)**  
 white | wit  
 ART-000320 brown | bruin



ART-000321 **Strap winder | Bandopwinder (11 m strap | band)**  
 white | wit  
 ART-000322 brown | bruin

## Parts list

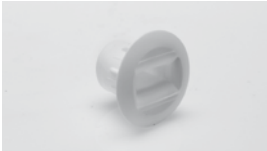
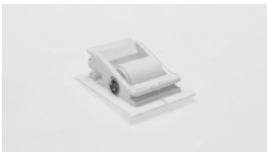
### Onderdelenlijst

Part Onderdeel	Part No. Art.nr	Description Omschrijving	Length in m' Unit
<b>WINDING MECHANISM STRAP   BANDWINDWERKEN</b>			
	ART-000323	<b>Winding mechanism strap   Bandwindwerk - 1:3</b> white   wit	
	ART-000324	brown   bruin	
	ART-000351	<b>Crank for winding mechanism strap</b> <b>Slinger voor bandwindwerk</b>	13 cm
	ART-000352		16 cm
	ART-000325	<b>Bevestigingshoek voor vertraging  </b> <b>Mounting piece for decelerator</b> white   wit	
<b>STRAP GUIDES   BANDGELEIDERS</b>			
	ART-000335	<b>Strap guide (14 mm) plastic insert with nylon roller  </b> <b>Bandgeleider (14 mm) kunststof insteek met nylon rol</b> white   wit	
	ART-000337	<b>Strap guide (14 mm) plastic insert  </b> <b>Bandgeleider (14 mm) kunststof inslag</b> white   wit	
	ART-000338	<b>Strap guide (14 mm) plastic for side cover  </b> <b>Bandgeleider (14 mm) kunststof voor zijkap</b> white   wit	
	ART-000339	brown   bruin	
	ART-000341	<b>Cover for strap guide plastic round  </b> <b>Afdekplaatje voor bandgeleiders PVC rond</b> white   wit	

## Parts list



### Onderdelenlijst

Part Onderdeel	Part No. Art.nr	Description Omschrijving	Length in m' Unit
<b>PULL-UP TAPE AND CORD   OPTREKBAND EN KOORD</b>			
	ART-000332	<b>Tape   Band 14 mm black-white   zwart-wit</b> black-white   zwart-wit	per mtr
	ART-020597	black-white   zwart-wit - 50m	per roll 50m
	ART-000347	<b>Cord   Koord - nylon 4.2 mm</b> black-white   zwart-wit	100 m
<b>CORD WINDERS   KOORDOPWINDERS</b>			
	ART-000343	<b>Cord winder   Koordopwinder - 4.5 mtr</b> white   wit	
	ART-035180	older type, can only be ordered separately.   ouder type, alleen als los artikel te bestellen.	
	ART-000344	<b>Cord winder   Koordopwinder - 11 mtr</b> white   wit	
	ART-000345	<b>Cord winder decelerator   Koordwindwerk vertraging - 1:3 tensile strength 3 kg, with freewheel   trekkracht 3 kg, met vrijloop</b> white   wit	
	ART-000351	<b>Crank for cord winder   Slinger voor koordwindwerk</b> 13 cm	
	ART-000352	16 cm	







## Parts list

### Onderdelenlijst

Part Onderdeel	Part No. Art.nr	Description Omschrijving	Length in m' Unit
<b>CORD GUIDE   KOORDGELEIDERS</b>			
	ART-000346	<b>Cord guide plastic, steel roll + spring</b> <b>Koordgeleider PVC, stalen rol + veer 250 mm</b> white   wit	
	ART-000349	<b>Cord guide plastic for side cover</b> <b>Koordgeleider PVC voor in zijkap</b> white   wit	
<b>(OOG)WINDWERKEN</b>			
	ART-000356	<b>Lifting gear 1:8, inside operation, square shaft 13 mm  </b> <b>Oogwindwerk 1:8, binnenbediening, vierkante as 13 mm</b> black   zwart	
	ART-000357	<b>Eye with square shaft 8 mm, length 15 cm</b> <b>Oog met vierkante as 8 mm, lengte 15 cm</b>	
	ART-000313	<b>Alu Bearing set 8K40 for mono</b> <b>Alu Lagerprop 8K40 voor mono</b>	
	ART-000314	<b>Alu Bearing set 8K40 for mono</b> <b>Alu Lagerprop 8K60 voor mono</b>	

## Parts list

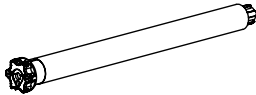
### Onderdelenlijst

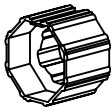
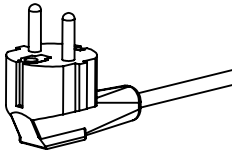
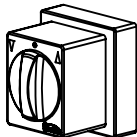
Part Onderdeel	Part No. Art.nr	Description Omschrijving	Length in m' Unit
<b>SPRING ROLLERS   VEERROLLEN</b>			
	ART-000361	<b>Spring roller for tube 8K60, length 60,5 cm, tensile strength 10 kg   Veerrol voor buis 8K60, lengte 60,5 cm, trekkracht 10 kg</b>	
	ART-000360	<b>Bracket for spring roller   Ophangbeugel t.b.v. veerrol</b>	
<b>PARTS FOR ELECTRICAL CONTROL   ONDERDELEN VOOR ELEKTRISCHE BEDIENING</b>			
		<b>Somfy motor</b>	
	ART-008903	<b>Somfy adaptor buis 8K60 Lt50   Somfy adaptor tube 8K60 Lt50</b>	
	ART-008929	<b>Somfy motorsteun Lt50-Lt60   Somfy motor support Lt50-Lt60</b>	
	ART-008917	<b>Somfy meenemer, buis 8K60 Lt50   Somfy driver, tube 8K60 Lt50</b>	
	ART-008876	<b>Haakse stekker PVC   Perpendicular power plug PVC</b> kabel   cable - 3 m	
	ART-046677	<b>Opbouw draaischakelaar   Wall-mounted rotating switch</b>	



BOLBYR

**BOLBYR®**

Bolbyr B.V. - Magazijnweg 27-29 - 5683 CV Best - Nederland (Netherlands)  
T +31 (0)88-9876543 - sales@bolbyr.com - www.bolbyr.com