

BOLBYR®

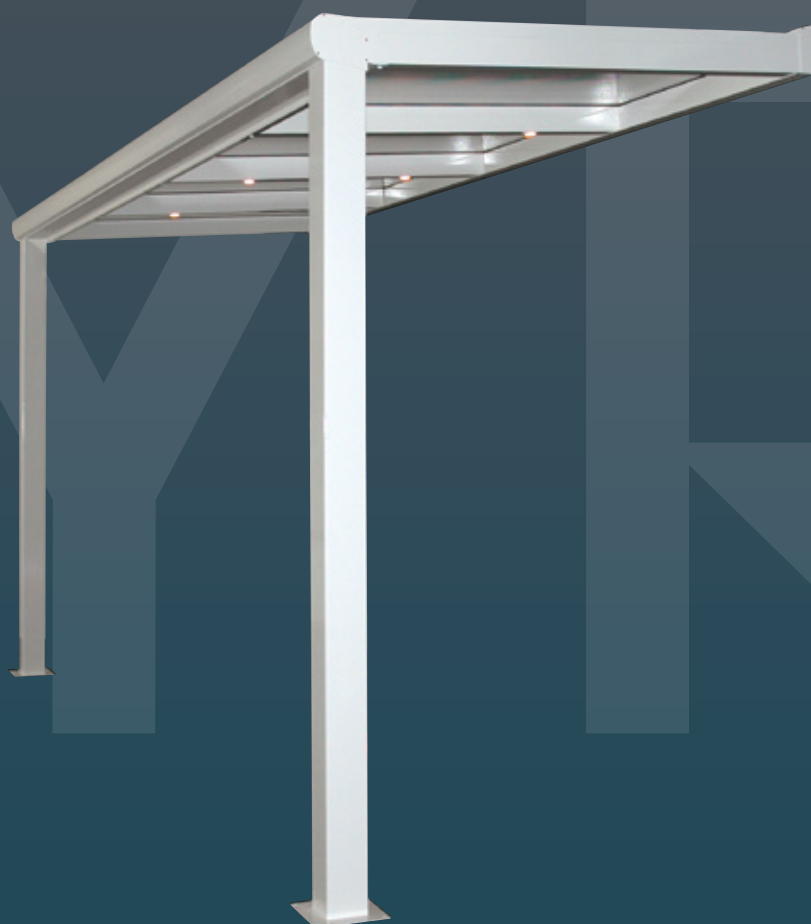

EN

NL

VERANDA | TERRASOVERKAPPING

YIZI

Subject to misprints, errors and technical modifications.
Drukfouten, fouten en technische wijzigingen voorbehouden.

25374046-240919-YIZI-EN-NL

Contents

Inhoudsopgave

Measurements

Maatvoering 4

Technical specifications

Technische specificaties6

Shortening sizes

Afkortmaten9

Exploded view10**Bill of material**

Stuklijst 11

Parts list

Onderdelenlijst..... 12

Additional technical information

Aanvullende technische informatie 17

Measurements

Maatvoering

Cross section | Doorsnede
 Sizes | Maten in mm

Standard gutter profil
Standaard gootprofiel

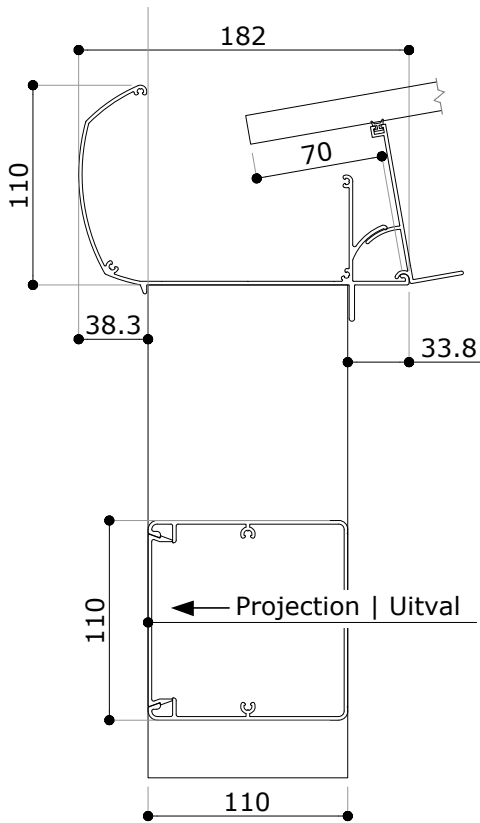

Classic gutter profile
Klassiek gootprofiel

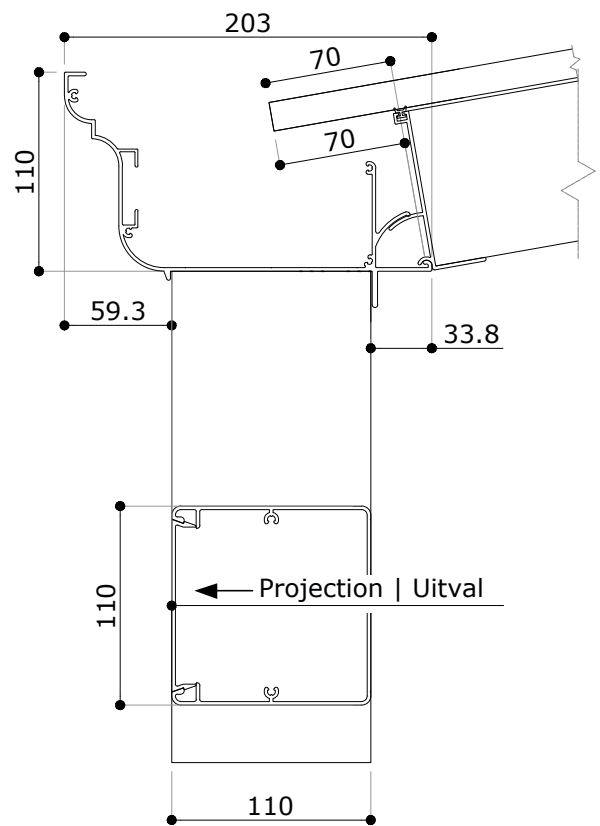

Wall profile
Wandprofiel

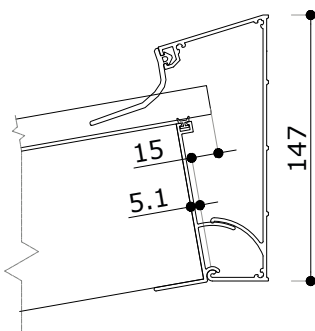

Measurements

Maatvoering

Cross section | Doorsnede
 Sizes | Maten in mm

Beam with side cover profile
Ligger met eindlijst

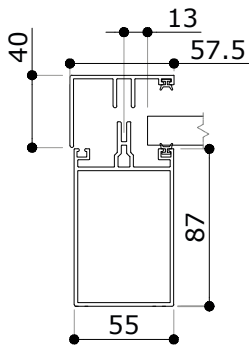

Beam with cover profile
Ligger met afdekljst

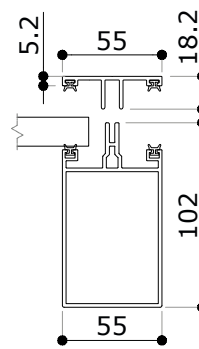

Beam with polycarbonate sheet 16 mm
Ligger met polycarbonaat plaat 16 mm

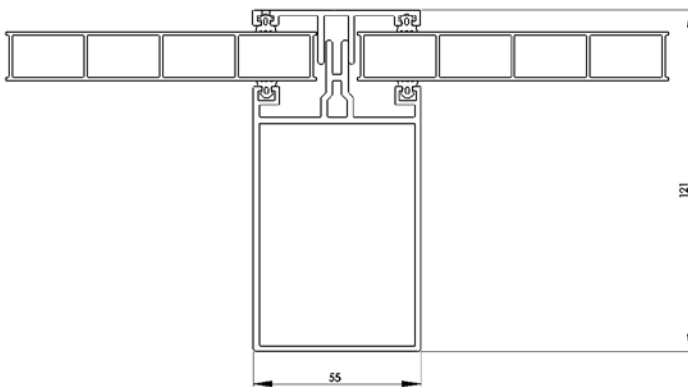

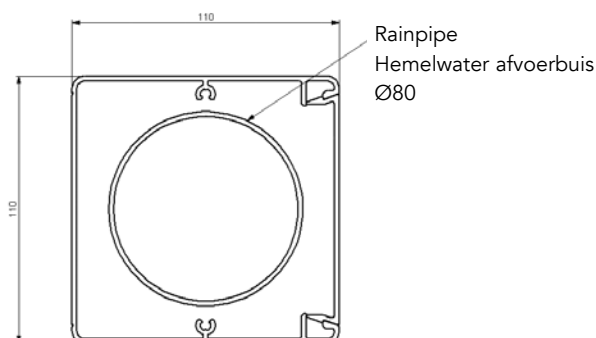

Post with drain
Stander met afvoerpijp

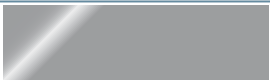
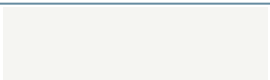

Technical specifications

Technische specificaties

Width Breedte	4000 - 5000 - 6000 - 7000 mm		
Projection Uitval	3000 - 3500 - 4000 mm		
Inclination Helling	8°		
Filling Vulling	Polycarbonate sheet 16 [mm] (Not possible with glass) Polycarbonaat plaat 16 [mm] (Niet mogelijk met glas)		
Available colors Beschikbare kleuren		mill finish onbewerkt	
		white wit	
		anthracite textured paint (VS716) antraciet structuurlak (VS716)	
		black textured paint (VS905) zwart structuurlak (VS905)	
Warning! Minimal color deviation reserved. Let op! Minimale kleurafwijking voorbehouden.			
CE certification CE keurmerk	CE NEN-EN 1090		

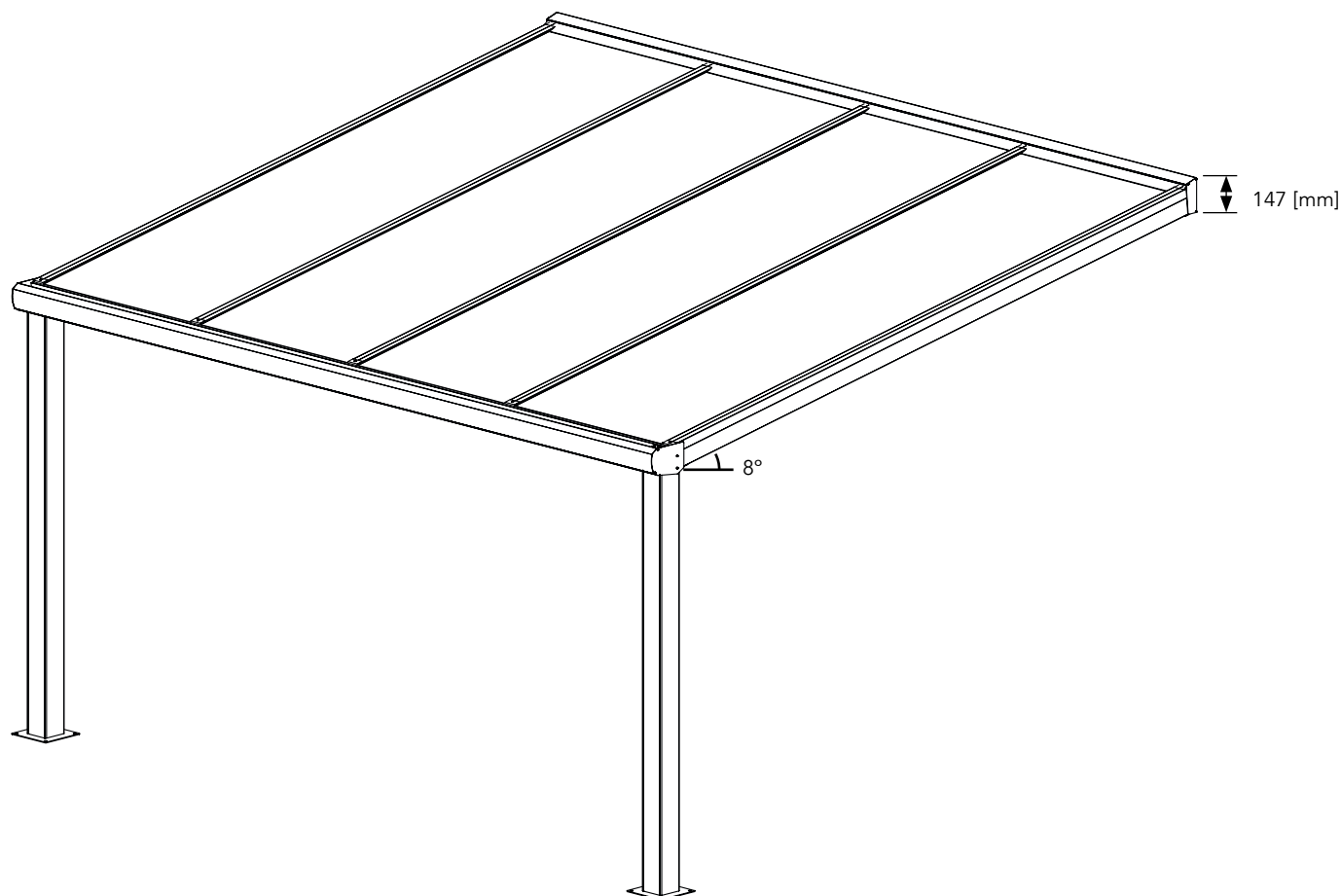

Technical specifications

Technische specificaties

B1	B2
4000	926
5000	929
6000	932
7000	933

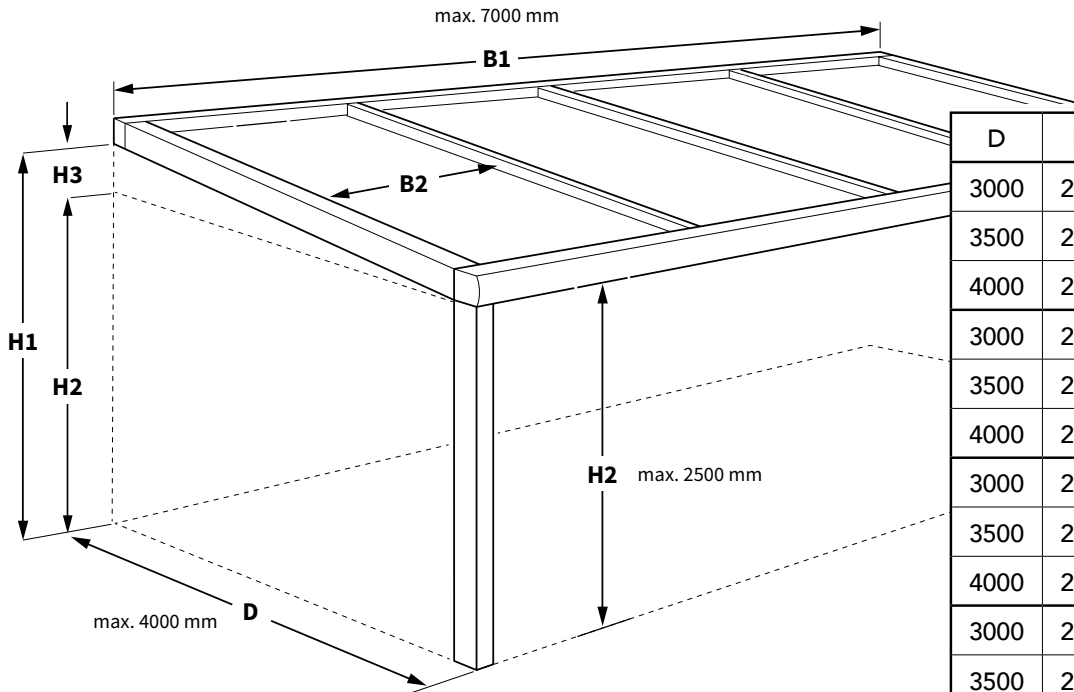

D	H2	H1	H3
3000	2100	2497	=H2+397
3500	2100	2568	=H2+468
4000	2100	2639	=H2+539
3000	2200	2597	=H2+397
3500	2200	2668	=H2+468
4000	2200	2739	=H2+539
3000	2300	2697	=H2+397
3500	2300	2768	=H2+468
4000	2300	2839	=H2+539
3000	2400	2797	=H2+397
3500	2400	2868	=H2+468
4000	2400	2939	=H2+539
3000	2500	2897	=H2+397
3500	2500	2968	=H2+468
4000	2500	3039	=H2+539

B = width | breedte
H = height | hoogte
D = projection | uitval

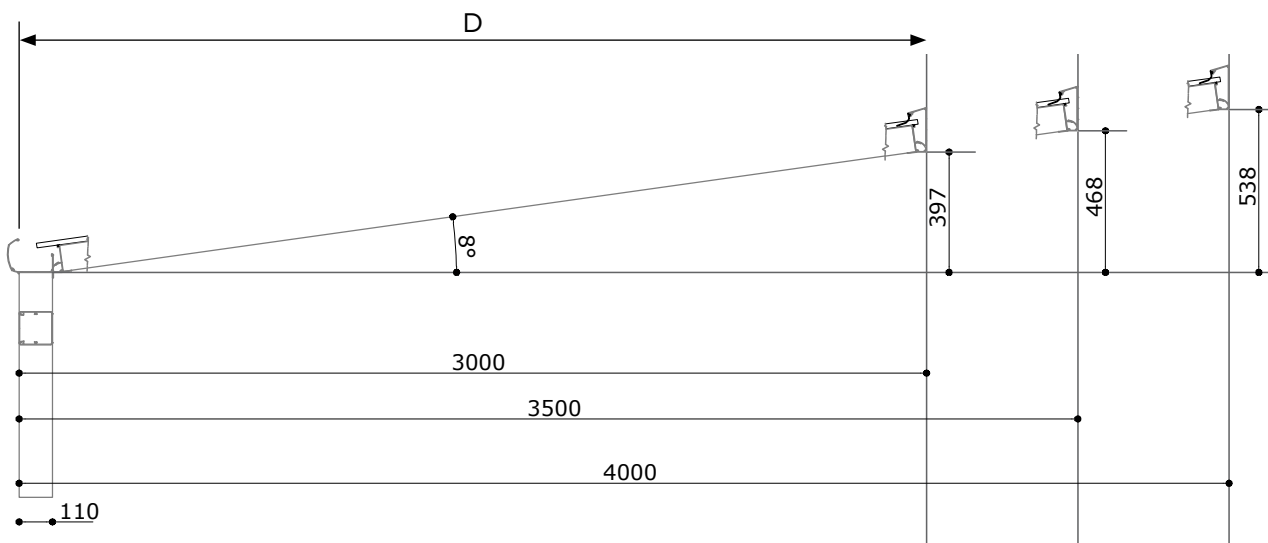

Technical specifications

Technische specificaties

STANDARD SIZES - Number of posts and fields STANDAARD MATEN - Aantal staanders en velden

Width Breedte [mm] x Projection Uitval [mm]	Minimal number of posts ¹ Minimaal aantal staanders ¹	Advised number of posts ² Geadviseerd aantal staanders ²	Number of fields Aantal velden
4000 x 3000	2	3	4
4000 x 3500	3		
4000 x 4000			
5000 x 3000	3	3	5
5000 x 3500			
5000 x 4000			
6000 x 3000	3	3	6
6000 x 3500		4	
6000 x 4000			
7000 x 3000	3	4	7
7000 x 3500			
7000 x 4000			

¹ Conform NEN normering.

² For use in combination with a glass wall | Voor gebruik in combinatie met een glaswand.

Shortening sizes

Afkortmaten

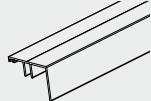
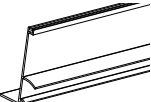
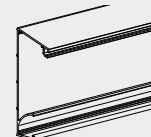
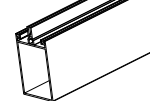
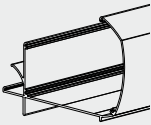
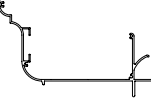
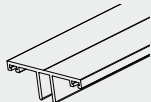
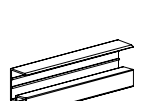
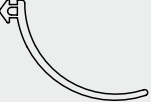
Part	Onderdeel		
1		Side cover profile beam Eindlijst ligger	depends on inclination afhankelijk van de helling
2		Hinge profile Scharnier profiel	- 9 mm
3		Wall profile Muurprofiel	- 5 mm
4		Beam Ligger	depends on inclination afhankelijk van de helling
5		Gutter Goot	- 5 mm
5		Gutter classic Goot klassiek	- 5 mm
6		Cover profile beam Afdeklijst ligger	depends on inclination afhankelijk van de helling
7		Condensate profile Condensprofiel polycarbonaat	- 0 mm from sheet size van plaatmaat
10		Rubber (wall profile) Rubberafdichting (muurprofiel)	- 5 mm

Exploded view

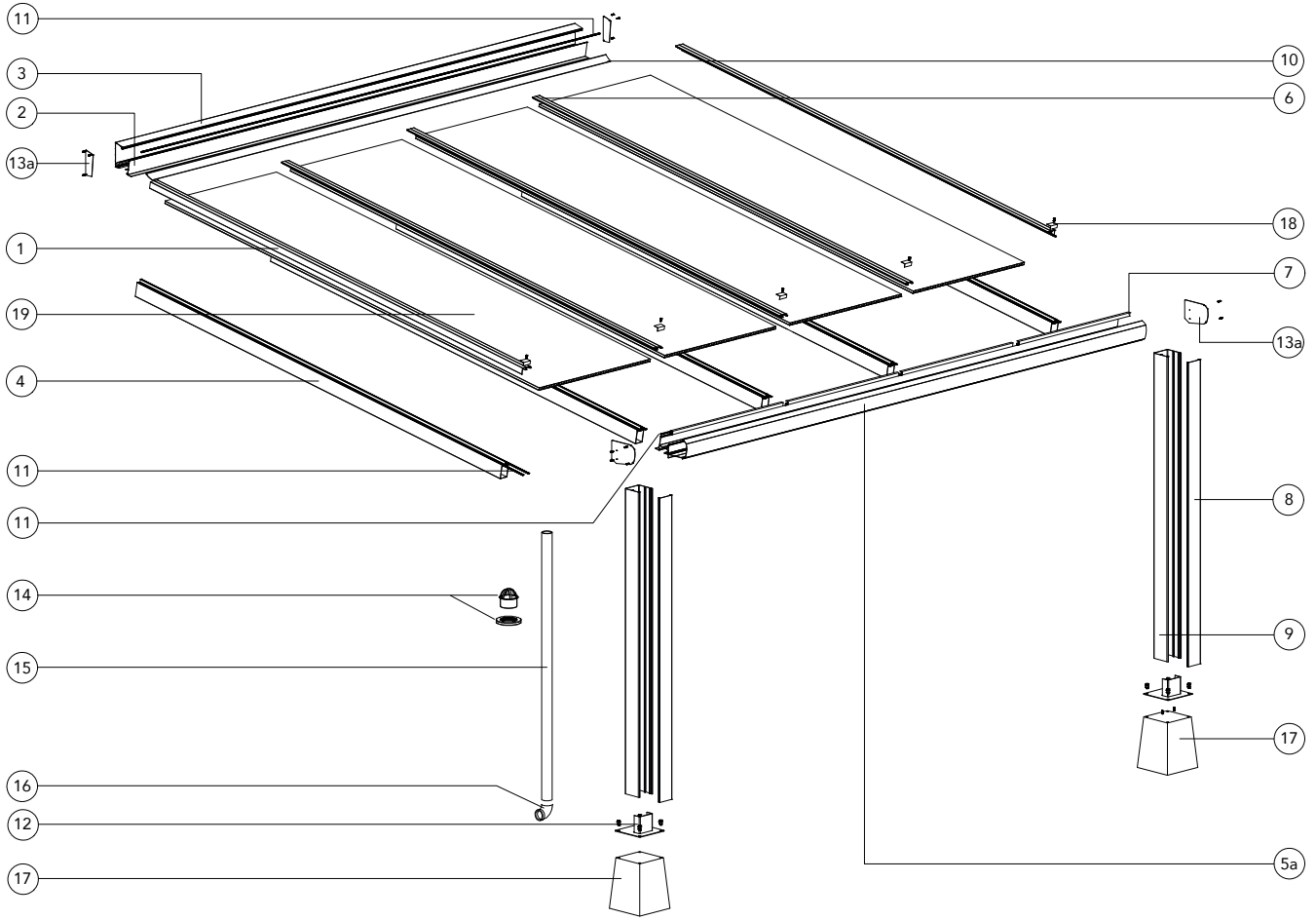

Bill of material

Stuklijst

Part Onderdeel	Description Omschrijving	Quantity Hoeveelheid
1	Side cover profile beam Eindlijst ligger	2
2	Hinge profile Scharnier profiel	2
3	Wall profile Muurprofiel	1
4	Beam Liggerprofiel	Number of fields +1 Aantal velden +1
5	Gutter profile Gootprofiel	1
6	Cover profile beam Afdeklijst ligger	Number of fields -1 Aantal velden -1
7	Condensate profile Condensprofiel	1
8	Post click profile flat Staander klikprofiel recht/vlak	Number of posts Aantal staanders
9	Post rear profile Staander achterprofiel	Number of posts Aantal staanders
10	Rubber for wall profile Rubberafdichting muurprofiel	1
11	Rubber co-extrusion (beams and hinge profile) Rubber co-extrusie (liggers en scharnierprofiel)	Number of fields x2 Aantal velden x2
12	Foot Montagevoet	Number of posts Aantal staanders
13	Side plates set Eindkappen set	1
14	Drop outlet Uitloop PVC Ø80 met wartel (Tule)	1
15	Drain Afvoerbuus	1
16	Curve drain Bocht afvoerbuus	1
17	Concrete block Betonpoer	Number of posts Aantal staanders
18	Angle (for 19) Hoek (voor 19) - 30x20 55mm	Number of fields +1 Aantal velden +1
19	Polycarbonate sheet Polycarbonaat plaat	Number of fields Aantal velden



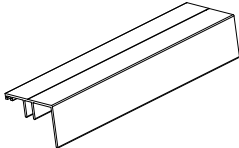
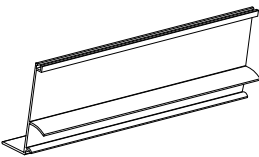
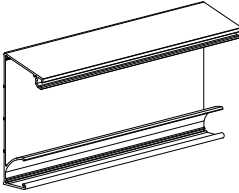
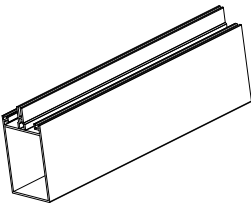

Parts list

Onderdelenlijst

Part Onderdeel	Part No. Art.nr	Description Omschrijving	Length in m ¹ Unit
LENGTHS LENGTES			
1 	ART-023946	Side cover profile beam Eindlijst ligger anthracite textured paint antraciet structuurlak (VS716)	6 m ¹
	ART-023947	mill finish onbewerkt	7 m ¹
	ART-023948	white wit	
	ART-023950 ART-044394	anthracite textured paint antraciet structuurlak (VS716) black textured paint zwart structuurlak (VS905)	
2 	ART-040358	Hinge profile Scharnier profiel white wit	4 m ¹
	ART-040362	anthracite textured paint antraciet structuurlak (VS716)	
	ART-023926	anthracite textured paint antraciet structuurlak (VS716)	5 m ¹
	ART-044403	black textured paint zwart structuurlak (VS905)	
	ART-023931	mill finish onbewerkt	7 m ¹
	ART-023932	white wit	
	ART-023934 ART-044404	anthracite textured paint antraciet structuurlak (VS716) black textured paint zwart structuurlak (VS905)	
3 	ART-040357	Wall profile Muurprofiel white wit	4 m ¹
	ART-023919	anthracite textured paint antraciet structuurlak (VS716)	6 m ¹
	ART-044401	black textured paint zwart structuurlak (VS905)	
	ART-023920	mill finish onbewerkt	7 m ¹
	ART-023921	white wit	
ART-023923 ART-044402	anthracite textured paint antraciet structuurlak (VS716) black textured paint zwart structuurlak (VS905)		
4 	ART-023935	Beam Liggerprofiel mill finish onbewerkt	6 m ¹
	ART-023936	white wit	
	ART-023938	anthracite textured paint antraciet structuurlak (VS716)	
	ART-044399	black textured paint zwart structuurlak (VS905)	
	ART-023939	mill finish onbewerkt	7 m ¹
	ART-023940	white wit	
	ART-023942 ART-044400	anthracite textured paint antraciet structuurlak (VS716) black textured paint zwart structuurlak (VS905)	

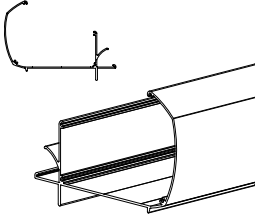
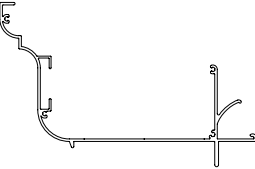
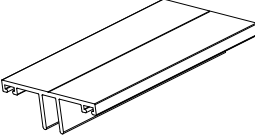

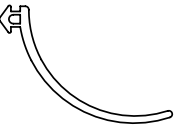
Parts list

Onderdelenlijst

Part Onderdeel	Part No. Art.nr	Description Omschrijving	Length in m ¹ Unit
5a 	ART-023961	Gutter profile standard Gootprofiel standaard anthracite textured paint antraciet structuurlak (VS716)	5 m ¹
	ART-023965	anthracite textured paint antraciet structuurlak (VS716)	6 m ¹
	ART-023966	mill finish onbewerkt	7 m ¹
	ART-023967	white wit	
	ART-023969	anthracite textured paint antraciet structuurlak (VS716)	
	ART-044395	black textured paint zwart structuurlak (VS905)	
5b 	ART-023974	Gutter profile classic Gootprofiel klassiek mill finish onbewerkt	7 m ¹
	ART-023975	white wit	
	ART-023977	anthracite textured paint antraciet structuurlak (VS716)	
	ART-044396	black textured paint zwart structuurlak (VS905)	
6 	ART-023954	Cover profile beam Afdekljst ligger anthracite textured paint antraciet structuurlak (VS716)	6 m ¹
	ART-023955	mill finish onbewerkt	7 m ¹
	ART-023956	white wit	
	ART-023958	anthracite textured paint antraciet structuurlak (VS716)	
7 	ART-023978	Condensate profile Condensprofiel polycarbonaat mill finish onbewerkt	6 m ¹
	ART-023979	white wit	
	ART-023981	anthracite textured paint antraciet structuurlak (VS716)	
	ART-044392	black textured paint zwart structuurlak (VS905)	
10 	ART-023339	Rubber for wall profile Rubberafdichting muurprofiel	per mtr
11 	ART-023340	Rubber co-extrusion (beams and hinge profile) Rubber co-extrusie (liggers en scharnierprofiel) 3000 mm	
	ART-023341	3500 mm	
	ART-023342	5000 mm	
	ART-023343	6000 mm	
	ART-023344	7000 mm	

Parts list

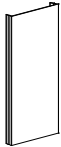
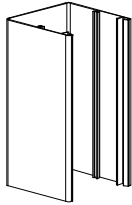
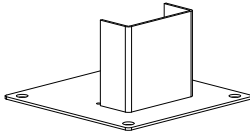
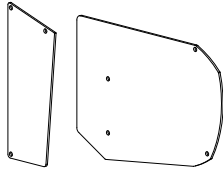
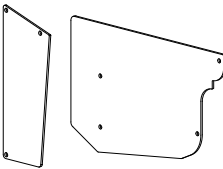
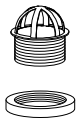
Onderdelenlijst

Part Onderdeel	Part No. Art.nr	Description Omschrijving	Length in m ¹ Unit
HEIGHTS HOOGTES			
8 	ART-023986	Post click profile flat Staander klikprofiel recht/vlak mill finish onbewerkt	5 m ¹
	ART-023987	white wit	
	ART-023989	anthracite textured paint antraciet structuurlak (VS716)	
	ART-044427	black textured paint zwart structuurlak (VS905)	
9 	ART-023982	Post rear profile Staander achterprofiel mill finish onbewerkt	5 m ¹
	ART-023983	white wit	
	ART-023985	anthracite textured paint antraciet structuurlak (VS716)	
	ART-044405	black textured paint zwart structuurlak (VS905)	
PARTS ONDERDELEN			
12 	ART-023346	Foot for concrete block Montagevoet voor betonpoer galvanized verzinkt	
13a 	ART-023386	Side plates standard Eindkappen standaard - SET mill finish onbewerkt	
	ART-023387	white wit	
	ART-023389	anthracite textured paint antraciet structuurlak (VS716)	
	ART-044390	black textured paint zwart structuurlak (VS905)	
13b 	ART-023406	Side plates classic Eindkappen klassiek - SET mill finish onbewerkt	
	ART-023407	white wit	
	ART-023409	anthracite textured paint antraciet structuurlak (VS716)	
14 	ART-023352	Drop outlet Uitloop met wartel (Tule) - PVC Ø80	
15 	ART-023350	Drain Afvoerbuiss - PVC Ø80 mm 2500 mm	

Parts list

Onderdelenlijst

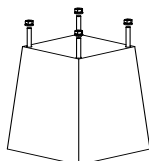
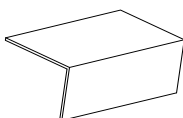
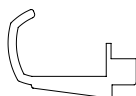
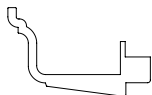
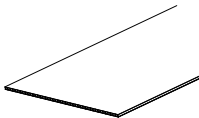
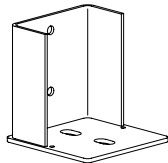
Part Onderdeel	Part No. Art.nr	Description Omschrijving	Length in m ¹ Unit
16	ART-023353	Curve Drain Bocht Afvoerbu	
			
17	ART-023345	Concrete block Betonpoer - 23x23x25 cm	
			
18	ART-023377 ART-023379 ART-044397	Angle Hoek - 30x20 55mm (for polycarbonate sheet voor polycarbonaat plaat) white wit anthracite textured paint antraciet structuurlak (VS716) black textured paint zwart structuurlak (VS905)	
			
	ART-023382 ART-023383	EPDM waterproof seal for side cover of the gutter standard EPDM waterdichte foamafdichting voor zijkap goot standaard white wit black zwart	
	ART-023384 ART-023385	EPDM waterproof seal for side cover of the gutter classic EPDM waterdichte foamafdichting voor zijkap goot klassiek white wit black zwart	
19	ART-023890 ART-023891 ART-023892 ART-023893 ART-023894 ART-023895 ART-039493 ART-023899	Polycarbonate sheet Polycarbonaat plaat - 16 mm clear helder - 600 x 098 clear helder - 700 x 098 clear helder - 700 x 120 opal opaal - 600 x 098 opal opaal - 700 x 098 opal opaal - 700 x 120 reflective zonwerend - 700 x 098 2-room clear 2-kamer helder - 700 x 098	6 m ¹ 7 m ¹ 7 m ¹ 6 m ¹ 7 m ¹ 7 m ¹ 7 m ¹ 7 m ¹
			
VARIOUS OVERIGEN			
	ART-023347	Foot small (inner size post - showroom) Montagevoet vlak (binnenmaat staander - showroom) galvanized verzinkt	

Parts list

Onderdelenlijst

Part Onderdeel	Part No. Art.nr	Description Omschrijving	Length in m' Unit
	ART-023348	Assembly set - Foot small (inner size post) Bevestigingsset - Montagevoet vlak (binnenmaat staander)	
	ART-023354 ART-023357 ART-023356	Assembly set Bevestigingsset white wit anthracite antraciet black zwart	
	ART-023411	Coupling piece gutter Koppelstuk goot standaard > 7000 mm (max. 14000 mm)	
	ART-023410	Coupling piece gutter classic Koppelstuk goot klassiek > 7000 mm (max. 14000 mm)	
	ART-023380	Antidust closed tape Gesloten tape - 16 mm	
	ART-023381	Antidust filtertape Filtertape - 16 mm	
	ART-023365	Lighting Set 1: 3x LED 2,5 Watt spots incl. driver (dimmable), puls switch and wires. Driver is suitable to control max. 12 LED spots.	
		Verlichtingset 1: 3x LED Watt spots incl. driver (dimbaar), pulsschakelaar en bekabeling. Driver is geschikt om max. 12 stuks LED spots te sturen.	
	ART-023367	Lighting Set 2: 3x LED 2,5 Watt spots incl. wires (no driver) (=complement to Set 2)	
		Verlichtingset 2: 3x LED 2,5 Watt spots incl. bekabeling (zonder driver) (=aanvulling op Set 2)	

Additional technical information

Aanvullende technische informatie

Processing the polycarbonate sheets Verwerking polycarbonaat platen

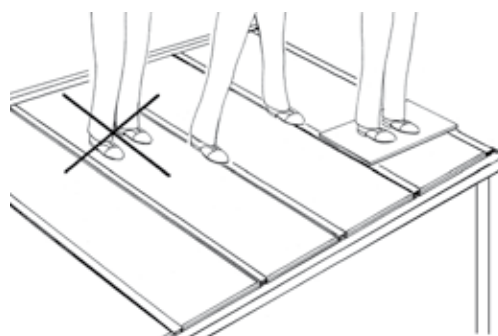
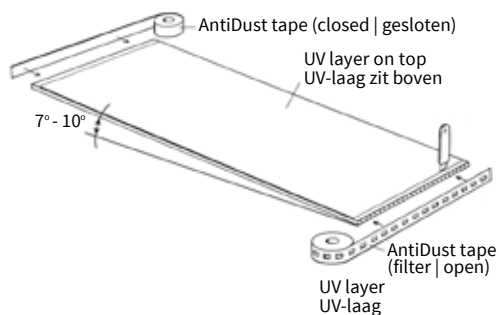
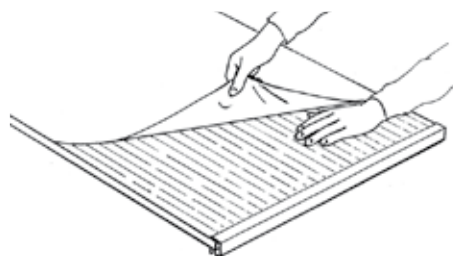
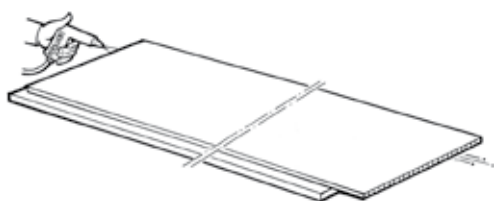
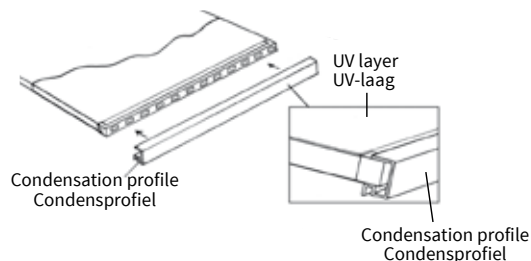

Warning! In the polycarbonate condensation may occur. This is not preventable and is no reason for replacement under warranty.

Let op! In het polycarbonaat kan condensatie optreden. Dit kan niet worden voorkomen en is geen reden voor vervanging onder garantie.

BOLBYR

BOLBYR®

Bolbyr B.V. - Magazijnweg 27-29 - 5683 CV Best - Nederland (Netherlands)
T +31 (0)88-9876543 - sales@bolbyr.com - www.bolbyr.com