

BOLBYR®



SCREEN

BOL ZIP TYPE 40

BOL ZIP TYPE 42

EN

NL

Subject to misprints, errors and technical modifications.
Drukfouten, fouten en technische wijzigingen voorbehouden.

20494679-231106NL-EN

Contents

Inhoudsopgave

Technical specifications	
Technische specificaties	4
Measurements	
Maatvoering	5
Scheme	
Schema	9
Shortening sizes	
Afkortmaten	12
Fabric finishing	
Doekafwerking	14
Guidelines weight	
Richtlijnen verzwaring.....	18
Distance bracket	
Afstandssteun.....	19
Exploded view	20
Bill of material (BOM)	
Stuklijst	21
Parts list	
Onderdelenlijst	
Type 40	
Bol Zip Type 40-XS	22
Bol Zip Type 40-S	24
Bol Zip Type 40-M	26
Bol Zip Type 40-L	28
Type 42	
Bol Zip Type 42-XS	30
Bol Zip Type 42-S	32
Bol Zip Type 42-M	34
Bol Zip Type 42-L	36
Bol Zip general algemeen	38
Additional technical information	
Aanvullende technische informatie	44

Technical specifications

Technische specificaties

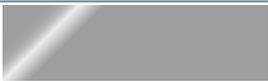
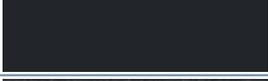
Type screen Type screen	closed cassette with integrated fabric guide gesloten cassette met geïntegreerde doekgeleiding	
Width Breedte	max. 5000 mm	
Height Hoogte	max. 5000 mm	
Max. surface Max. oppervlakte	18 m ²	
Control Bediening	motorized elektrisch	
Available colors Beschikbare kleuren		mill finish onbewerkt
		white wit
		ivory (RAL 9001) ivoor (RAL 9001)
		anodized technisch zilver
		anthracite (RAL 7016) antraciet (RAL 7016)
		anthracite textured paint (VS716) antraciet structuurlak (VS716)
		black textured paint (VS 905) zwart structuurlak (VS 905)
Minimal required Nm Minimaal benodigd Nm		6 Nm
Applicable fabric Toepasbaar doek	fibreglass fabric glasvezel doek	

Measurements

Maatvoering

XS

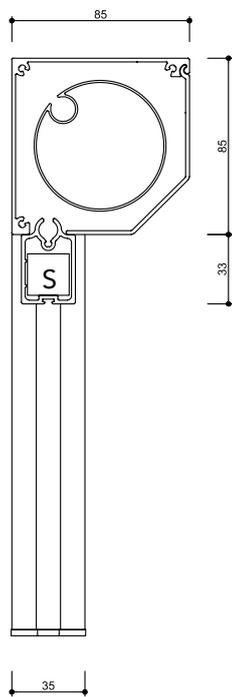

S

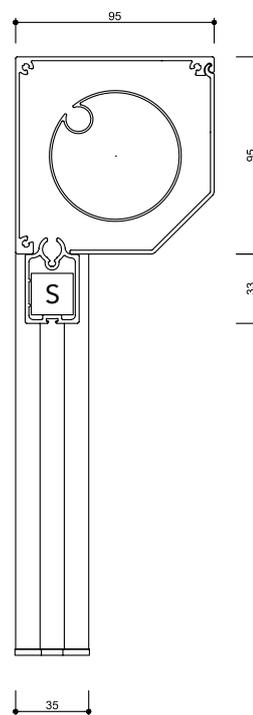

Cross section | Doorsnede

M

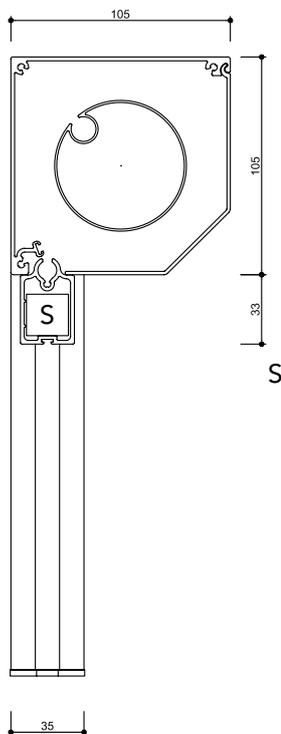

L

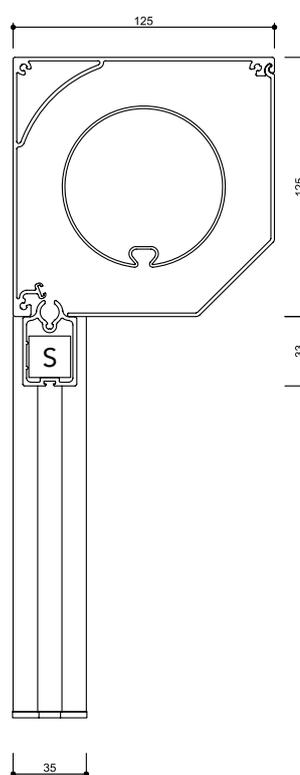

Measurements

Maatvoering

XS

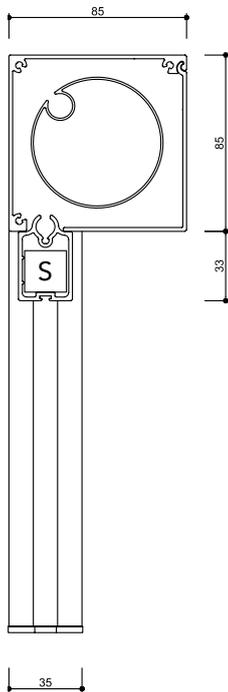

S

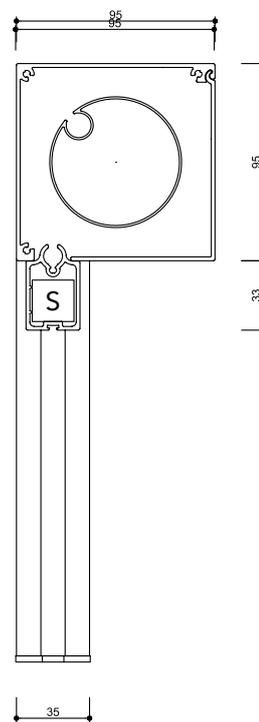

Cross section | Doorsnede

M

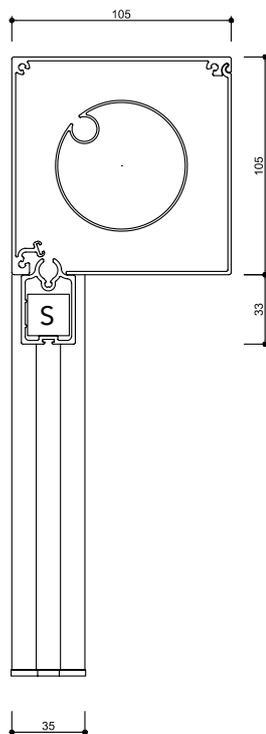

L

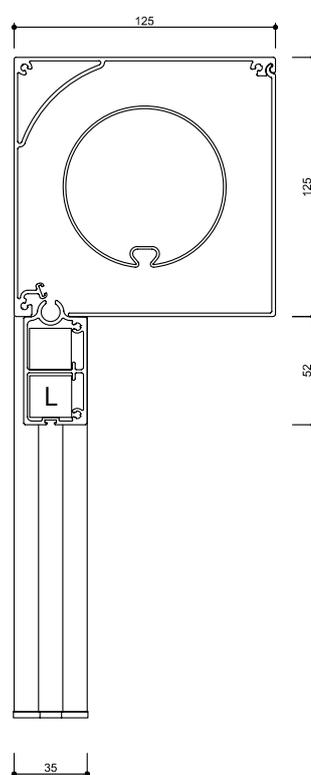

Measurements

Maatvoering

Bottom bars | Onderlijsten

Cross section | Doorsnede

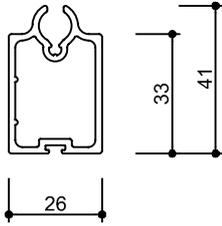

S

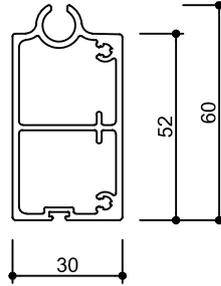

L

Side guides | Zijgeleiders

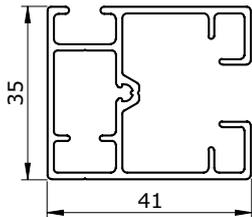

SINGLE guide
Zijgeleider 1-DELIG

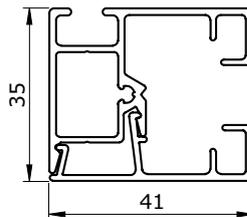

Two-part guide CLICK
Zijgeleider 2-delig KLIK

Only possible to be placed:
on the frame ("outside mount")

Alleen geschikt voor:
'op de dag' montage

Possible to be placed:
in the frame ("inside mount") and
on the frame ("outside mount")

Geschikt voor:
'op de dag' en 'in de dag' montage

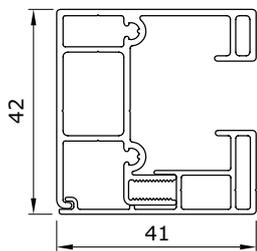

Two-part guide SCREW
suitable for verandas
Zijgeleider 2-delig SCHROEF
toepasbaar bij verandas

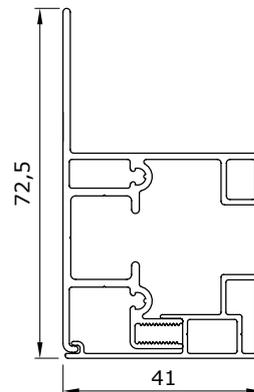

Two-part guide SCREW
with extension
Zijgeleider 2-delig SCHROEF
met lip

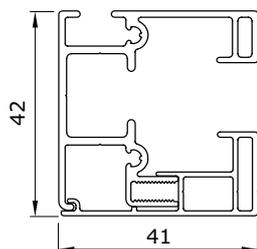

Two-part guide SCREW
with cable entry
Zijgeleider 2-delig SCHROEF
met kabeldoorgang

Measurements

Maatvoering

Bol Zip	Tube Doekbuis	Max. ←→	Max. ↑↓	Max. ↕
XS	ø63 mm	3400 mm	1500 mm	5 m ²
S	ø63 mm	4000 mm	3000 mm	12 m ²
M	ø63 mm	4000 mm	3500 mm	14 m ²
	ø78 mm	4000 mm	2600 mm	10 m ²
L	ø78 mm	6000 mm	5000 mm	18 m ²
	ø100 mm	6000 mm	2800 mm	14 m ²

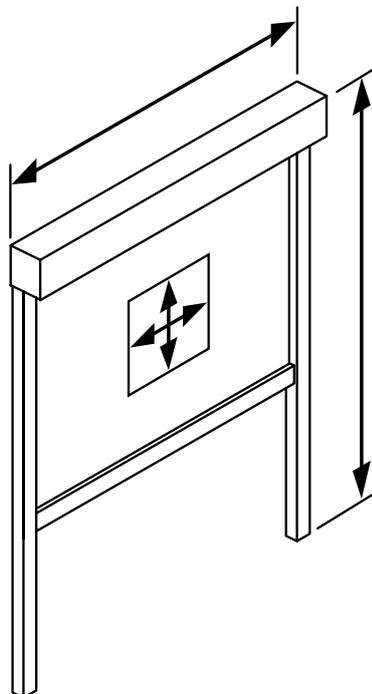

Scheme

Schema

XS

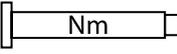
Minimal required
Minimaal benodigd 

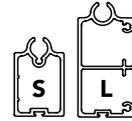

63

↑ [mm]	↔ [mm]												
	1000	1200	1400	1600	1800	2000	2200	2400	2600	2800	3000	3200	3400
1000	6	6	6	6	6	6	6	6	6	6	6	6	6
1100	6	6	6	6	6	6	6	6	6	6	6	6	6
1200	6	6	6	6	6	6	6	6	6	6	6	6	6
1300	6	6	6	6	6	6	6	6	6	6	6	6	15
1400	6	6	6	6	6	6	6	6	6	6	6	6	15
1500	6	6	6	6	6	6	6	6	6	6	6	15	15

S

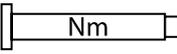
Minimal required
Minimaal benodigd 

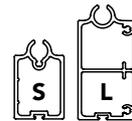

63

↑ [mm]	↔ [mm]															
	1000	1200	1400	1600	1800	2000	2200	2400	2600	2800	3000	3200	3400	3600	3800	4000
1000	6	6	6	6	6	6	6	6	6	6	6	6	6	6	6	15
1100	6	6	6	6	6	6	6	6	6	6	6	6	6	6	15	15
1200	6	6	6	6	6	6	6	6	6	6	6	6	6	15	15	15
1300	6	6	6	6	6	6	6	6	6	6	6	6	15	15	15	15
1400	6	6	6	6	6	6	6	6	6	6	6	6	15	15	15	15
1500	6	6	6	6	6	6	6	6	6	6	6	15	15	15	15	15
1600	6	6	6	6	6	6	6	6	6	6	6	15	15	15	15	15
1700	6	6	6	6	6	6	6	6	6	6	15	15	15	15	15	15
1800	6	6	6	6	6	6	6	6	6	6	15	15	15	15	15	15
1900	6	6	6	6	6	15	15	15	15	15	15	15	15	15	15	15
2000	6	6	6	6	6	15	15	15	15	15	15	15	15	15	15	15
2100	6	6	6	6	15	15	15	15	15	15	15	15	15	15	15	15
2200	6	6	6	6	15	15	15	15	15	15	15	15	15	15	15	15
2300	6	6	6	6	15	15	15	15	15	15	15	15	15	15	15	15
2400	6	6	6	6	15	15	15	15	15	15	15	15	15	15	15	15
2500	6	6	6	15	15	15	15	15	15	15	15	15	15	15	15	15
2600	6	6	6	15	15	15	15	15	15	15	15	15	15	15	15	15
2700	6	6	6	15	15	15	15	15	15	15	15	15	15	15	15	15
2800	6	6	6	15	15	15	15	15	15	15	15	15	15	15	15	15
2900	6	6	6	15	15	15	15	15	15	15	15	15	15	15	15	15
3000	6	6	6	15	15	15	15	15	15	15	15	15	15	15	15	15

Scheme

Schema

M

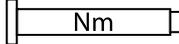
Minimal required
Minimaal benodigd 

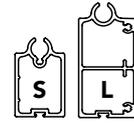

63 **78**

↑ [mm]	↔ [mm]															
	1000	1200	1400	1600	1800	2000	2200	2400	2600	2800	3000	3200	3400	3600	3800	4000
1000	6	6	6	6	6	6	6	6	6	6	10	10	10	10	10	10
1100	6	6	6	6	6	6	6	6	6	10	10	10	10	10	10	10
1200	6	6	6	6	6	6	6	6	6	10	10	10	10	10	10	10
1300	6	6	6	6	6	6	6	6	6	10	10	10	10	10	10	10
1400	6	6	6	6	6	6	6	6	10	10	10	10	10	10	10	10
1500	6	6	6	6	6	6	6	6	10	10	10	10	10	10	10	10
1600	6	6	6	6	6	6	6	10	10	10	10	10	10	10	10	10
1700	6	6	6	6	6	6	6	10	10	10	10	10	10	10	10	10
1800	6	6	6	6	6	6	6	10	10	10	10	10	10	10	10	10
1900	6	6	6	6	6	6	10	10	10	10	10	10	10	10	10	10
2000	6	6	6	6	6	6	10	10	10	10	10	10	10	10	10	10
2100	6	6	6	6	6	6	10	10	10	10	10	10	10	10	10	15
2200	6	6	6	6	6	10	10	10	10	10	10	10	10	10	10	15
2300	6	6	6	6	6	10	10	10	10	10	10	10	10	10	15	15
2400	6	6	6	6	10	10	10	10	10	10	10	10	10	10	15	15
2500	6	6	6	6	10	10	10	10	10	10	10	10	10	10	15	15
2600	6	6	6	6	6	6	10	10	10	10	10	10	10	10	10	10
2700	6	6	6	6	6	10	10	10	10	10	10	10	10	10	10	10
2800	6	6	6	6	6	10	10	10	10	10	10	10	10	10	10	10
2900	6	6	6	6	6	10	10	10	10	10	10	10	10	10	10	15
3000	6	6	6	6	10	10	10	10	10	10	10	10	10	10	10	15
3100	6	6	6	6	10	10	10	10	10	10	10	10	10	10	10	15
3200	6	6	6	6	10	10	10	10	10	10	10	10	10	10	15	15
3300	6	6	6	10	10	10	10	10	10	10	10	10	10	10	15	15
3400	6	6	6	10	10	10	10	10	10	10	10	10	10	15	15	15
3500	6	6	10	10	10	10	10	10	10	10	10	10	10	15	15	15

Shortening sizes

Afkortmaten

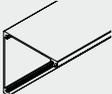
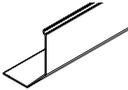
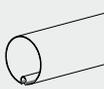
Part Onderdeel	XS	S	M	L
 Top cover Bovenkap	↔	- 6 mm		
 Bottom cover Type 40 Onderkap Type 40	↔	- 6 mm		
 Bottom cover Type 42 Onderkap Type 42	↔	- 6 mm		
 Bottom bar S Onderlijst S	↔	- 100 mm		
 Bottom bar L Onderlijst L	↔	- 100 mm		
 Tube ø63 Doekbuis ø63 - 0,9 mm	↔		Depending on the brand of the motor Afhankelijk van het merk motor	
 Tube ø78 Doekbuis ø78 - 1,25 mm	↔		Depending on the brand of the motor Afhankelijk van het merk motor	
 Tube ø100 Doekbuis ø100	↔		Depending on the brand of the motor Afhankelijk van het merk motor	
 Weight bottom bar S Verzwaringsstaf onderlijst S	↔	- 150 mm		
 Weight bottom bar L Verzwaringsstaf onderlijst L	↔	- 150 mm		
 PVC pipe PVC buis	↔		See page 18 Zie pagina 18	

Shortening sizes

Afkortmaten

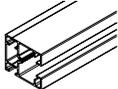
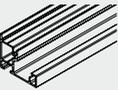
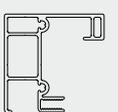
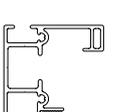
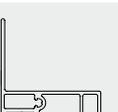
Part Onderdeel			XS	S	M	L
	SINGLE guide Zijgeleider 1-DELIG		- 88 mm	- 98 mm	- 108 mm	- 128 mm
	Back profile two-part guide CLICK Achterprofiel zijgeleider 2-delig KLIK		- 88 mm	- 98 mm	- 108 mm	- 128 mm
	Front profile two-part guides CLICK Voorprofiel zijgeleider 2-delig KLIK		- 88 mm	- 98 mm	- 108 mm	- 128 mm
	Back profile two-part guide SCREW, suitable for verandas Achterprofiel zijgeleider 2-delig SCHROEF, toepasbaar bij verandas		- 88 mm	- 98 mm	- 108 mm	- 128 mm
	Back profile two-part guide SCREW with cable entry Achterprofiel zijgeleider 2-delig SCHROEF met kabeldoorgang		- 88 mm	- 98 mm	- 108 mm	- 128 mm
	Back profile two-part guide SCREW with extension Achterprofiel zijgeleider 2-delig SCHROEF met lip		- 88 mm	- 98 mm	- 108 mm	- 128 mm
	Front profile two-part guide SCREW Achterprofiel zijgeleider 2-delig SCHROEF		- 88 mm	- 98 mm	- 108 mm	- 128 mm
	PVC fabric guide Geleidersprofiel kunststof		- 89 mm	- 99 mm	- 109 mm	- 129 mm

Fabric finishing

Doek afwerking

XS

Based on a screen of 1000 mm x 1000 mm.
Op basis van een screen van 1000 mm x 1000 mm.

Shortening sizes Afkortmaten

Tube Somfy LT50 motor
Buis Somfy LT50 motor - 121 mm

Tube Somfy LS40 motor
Buis Somfy LS40 motor - 115 mm

Bottom bar
Onderlijst - 100 mm

Finished fabric width
Afgewerkte doekbreedte - 59 mm

Cutting size fabric width
Snijmaat doekbreedte - 68 mm

Finished fabric height
Afgewerkte doekhoogte + 20 mm

Cutting size fabric height
Snijmaat doekhoogte + 50 mm

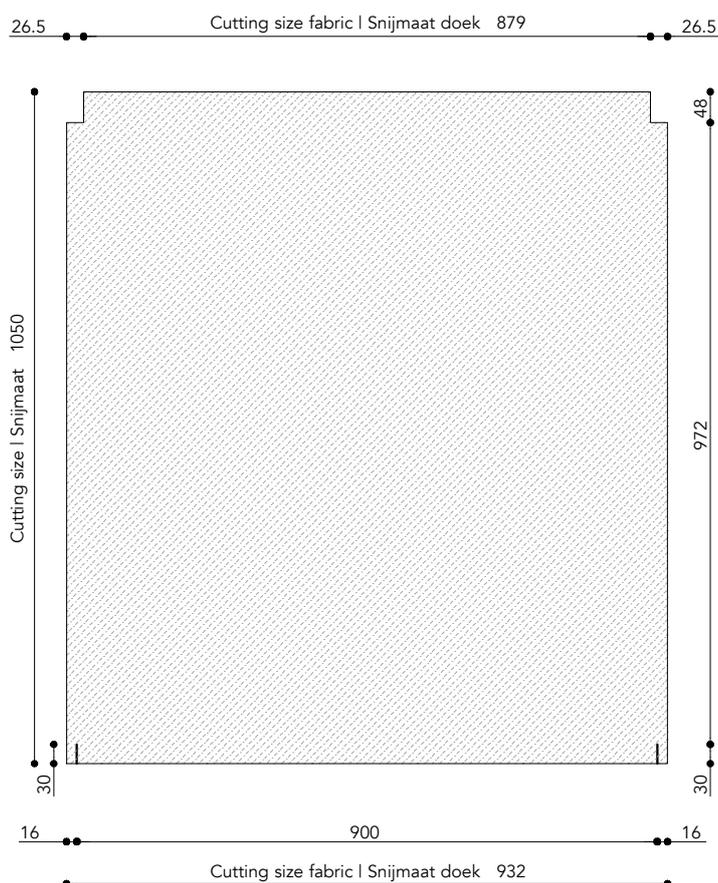
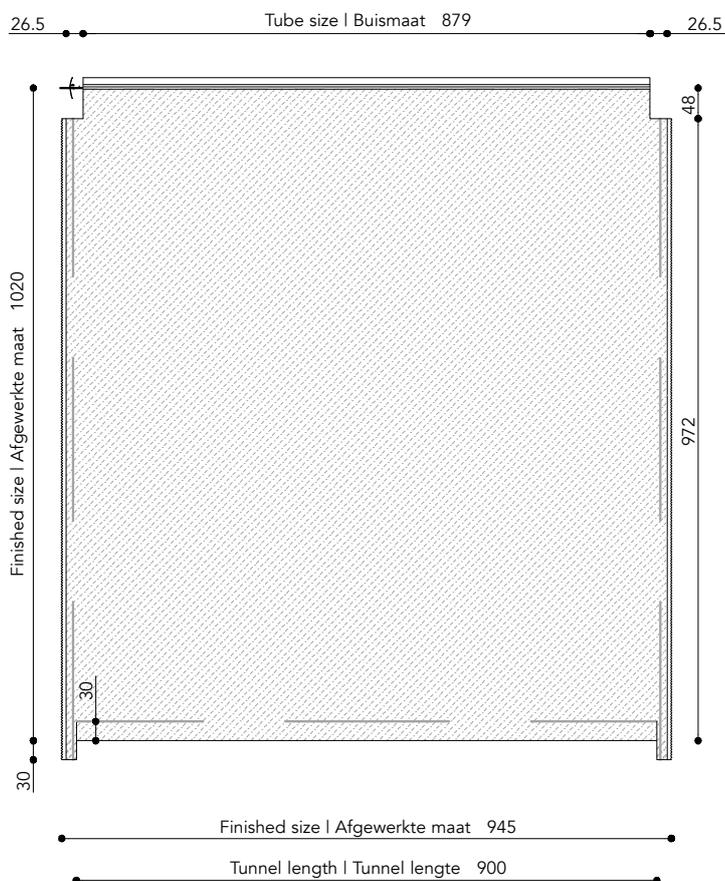

Fabric finishing

Doek afwerking

S

Based on a screen of 1000 mm x 1000 mm.
Op basis van een screen van 1000 mm x 1000 mm.

Shortening sizes Afkortmaten

Tube Somfy LT50 motor
Buis Somfy LT50 motor - 121 mm

Tube Somfy LS40 motor
Buis Somfy LS40 motor - 115 mm

Bottom bar
Onderlijst - 100 mm

Finished fabric width
Afgewerkte doekbreedte - 59 mm

Cutting size fabric width
Snijmaat doekbreedte - 68 mm

Finished fabric height
Afgewerkte doekhoogte + 16 mm

Cutting size fabric height
Snijmaat doekhoogte + 46 mm

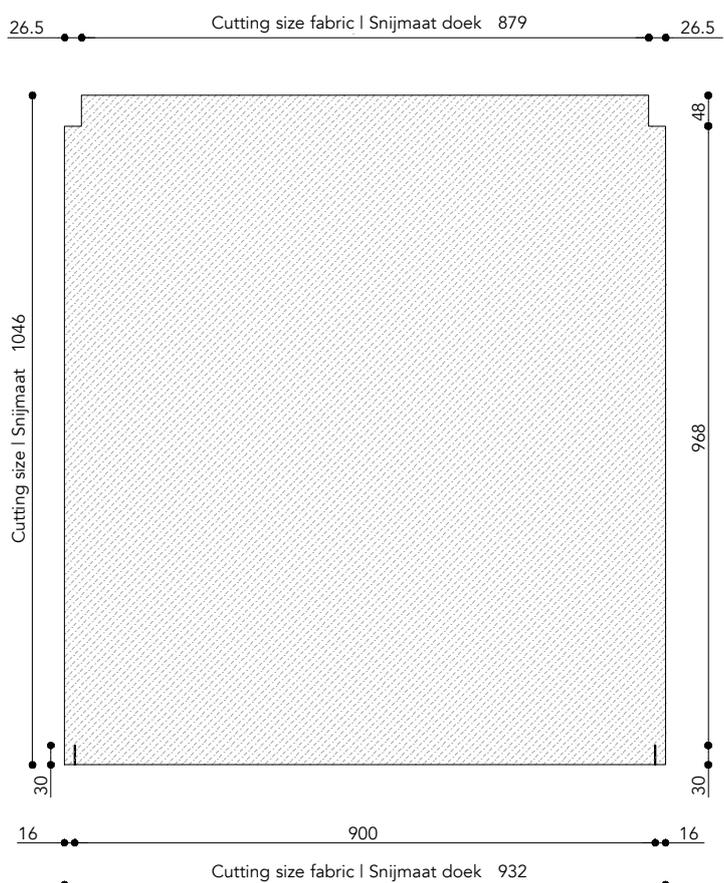
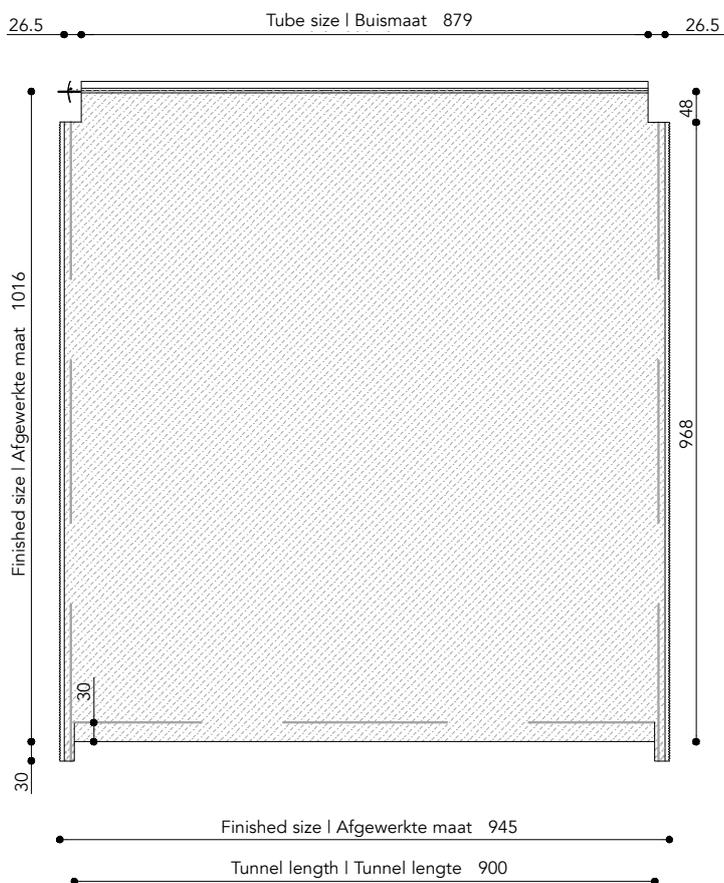

Fabric finishing

Doek afwerking

M

Based on a screen of 1000 mm x 1000 mm.
Op basis van een screen van 1000 mm x 1000 mm.

Shortening sizes Afkortmaten

Tube Somfy LT50 motor
Buis Somfy LT50 motor - 121 mm

Tube Somfy LS40 motor
Buis Somfy LS40 motor - 115 mm

Bottom bar
Onderlijst - 100 mm

Finished fabric width
Afgewerkte doekbreedte - 59 mm

Cutting size fabric width
Snijmaat doekbreedte - 68 mm

Finished fabric height
Afgewerkte doekhoogte + 34 mm

Cutting size fabric height
Snijmaat doekhoogte + 64 mm

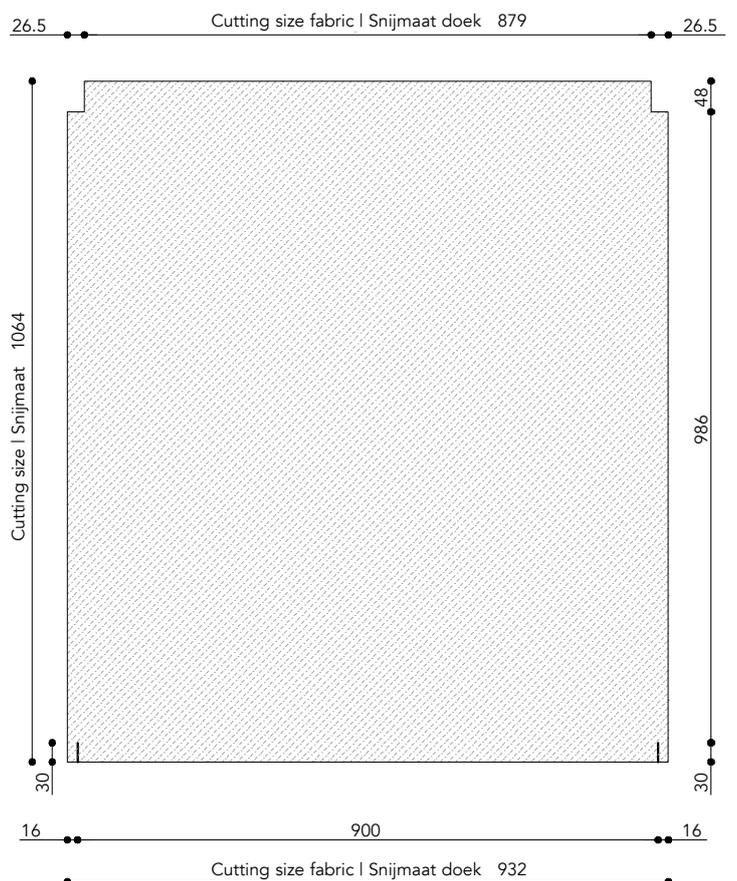
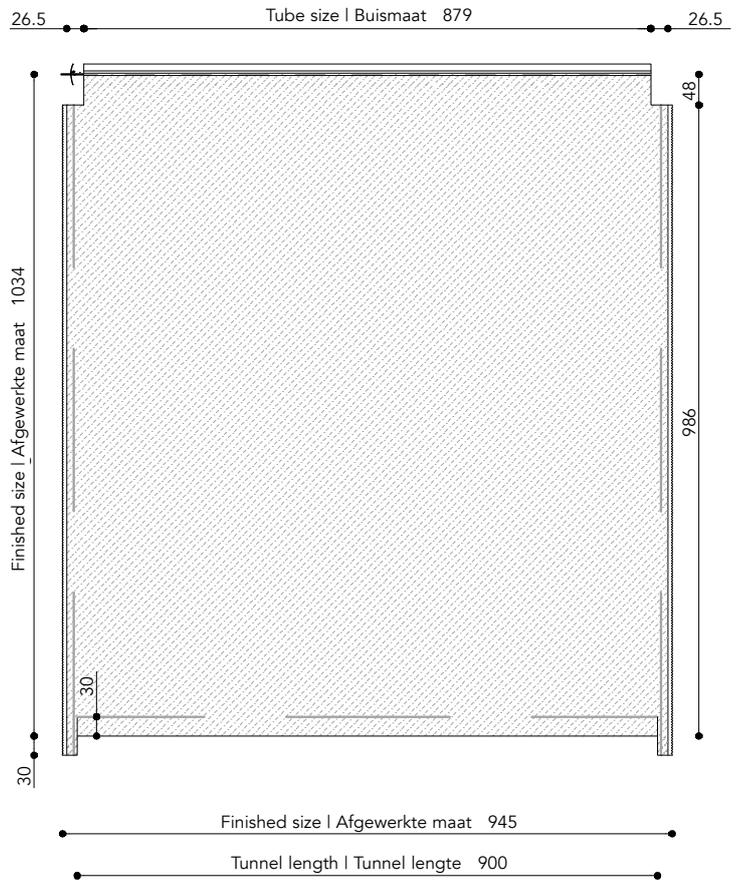

Fabric finishing

Doek afwerking

L

Based on a screen of 1000 mm x 1000 mm.
Op basis van een screen van 1000 mm x 1000 mm.

Shortening sizes Afkortmaten

Tube Somfy LT50 motor Buis Somfy LT50 motor	- 121 mm
Tube Somfy LS40 motor Buis Somfy LS40 motor	- 115 mm
Bottom bar Onderlijst	- 100 mm
Finished fabric width Afgewerkte doekbreedte	- 59 mm
Cutting size fabric width Snijmaat doekbreedte	- 68 mm
Finished fabric height Afgewerkte doekhoogte	+ 24 mm
Cutting size fabric height Snijmaat doekhoogte	+ 54 mm

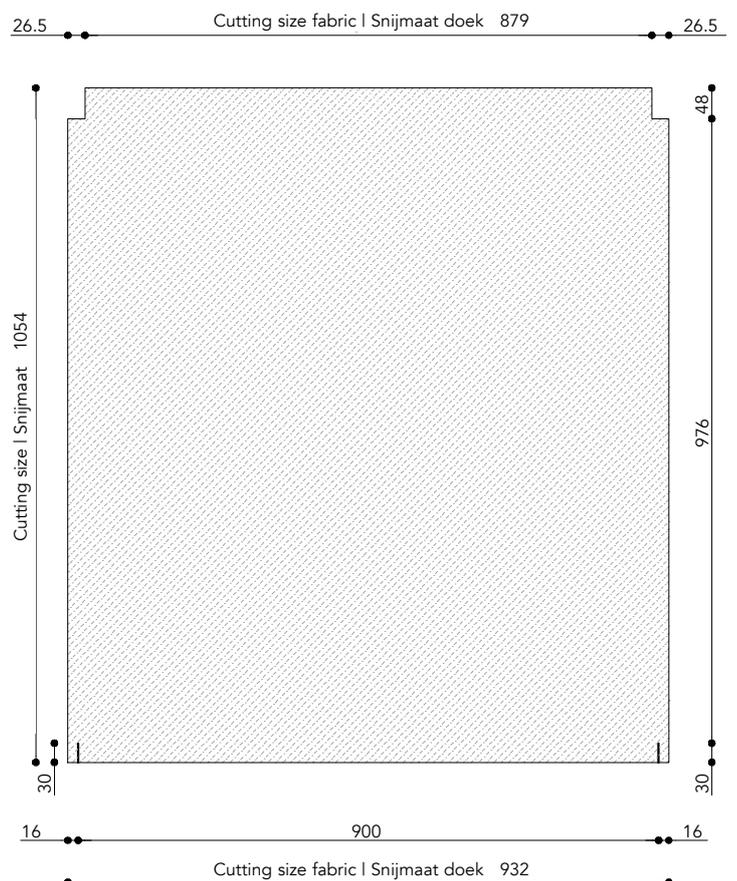
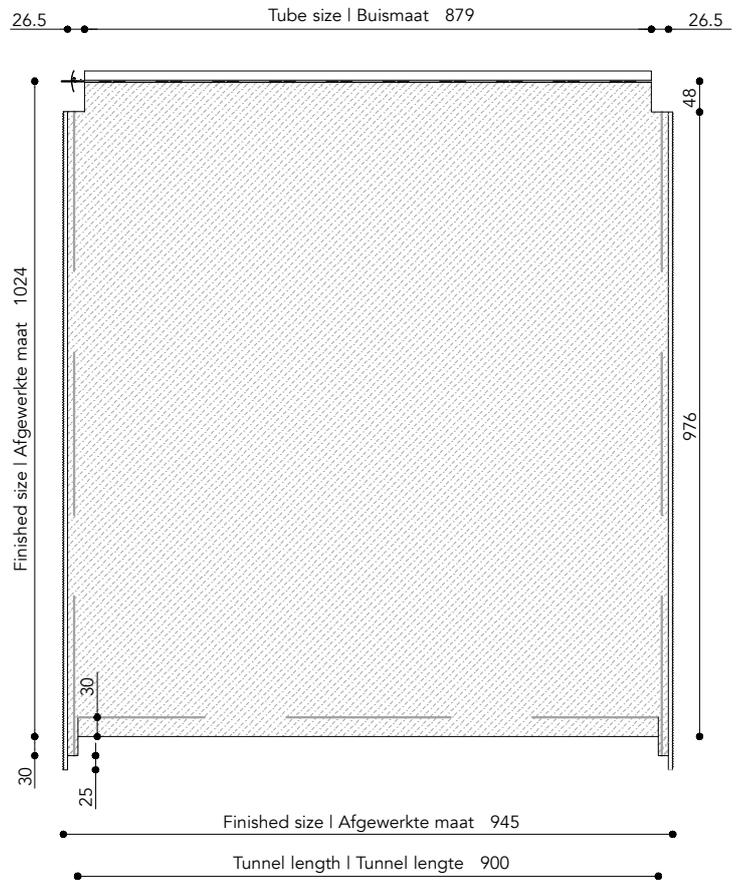

Guidelines weight

Richtlijnen verzwaring

Bottom bars | Onderlijsten

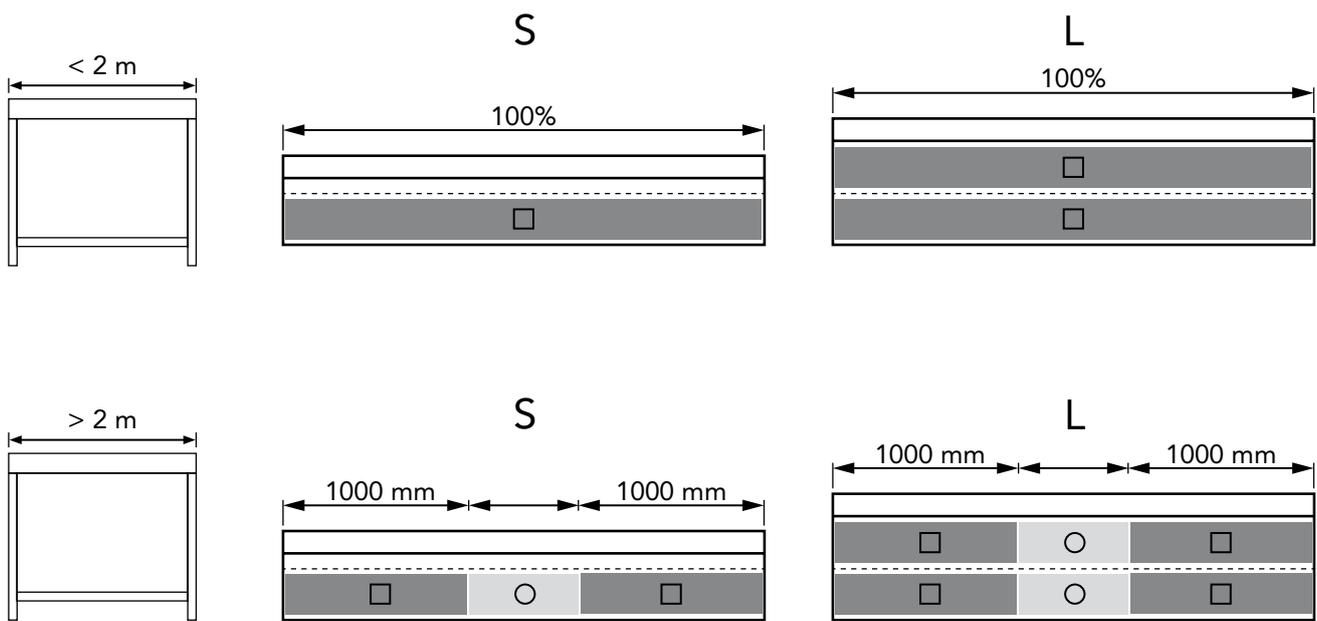
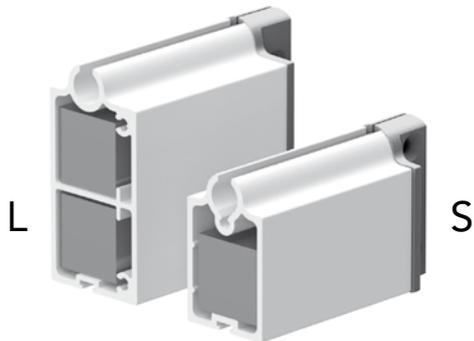

□ Weight bottom slat | Verzwaringstaf 20x20mm

○ PVC pipe | PVC buis

Distance bracket

Afstandssteun

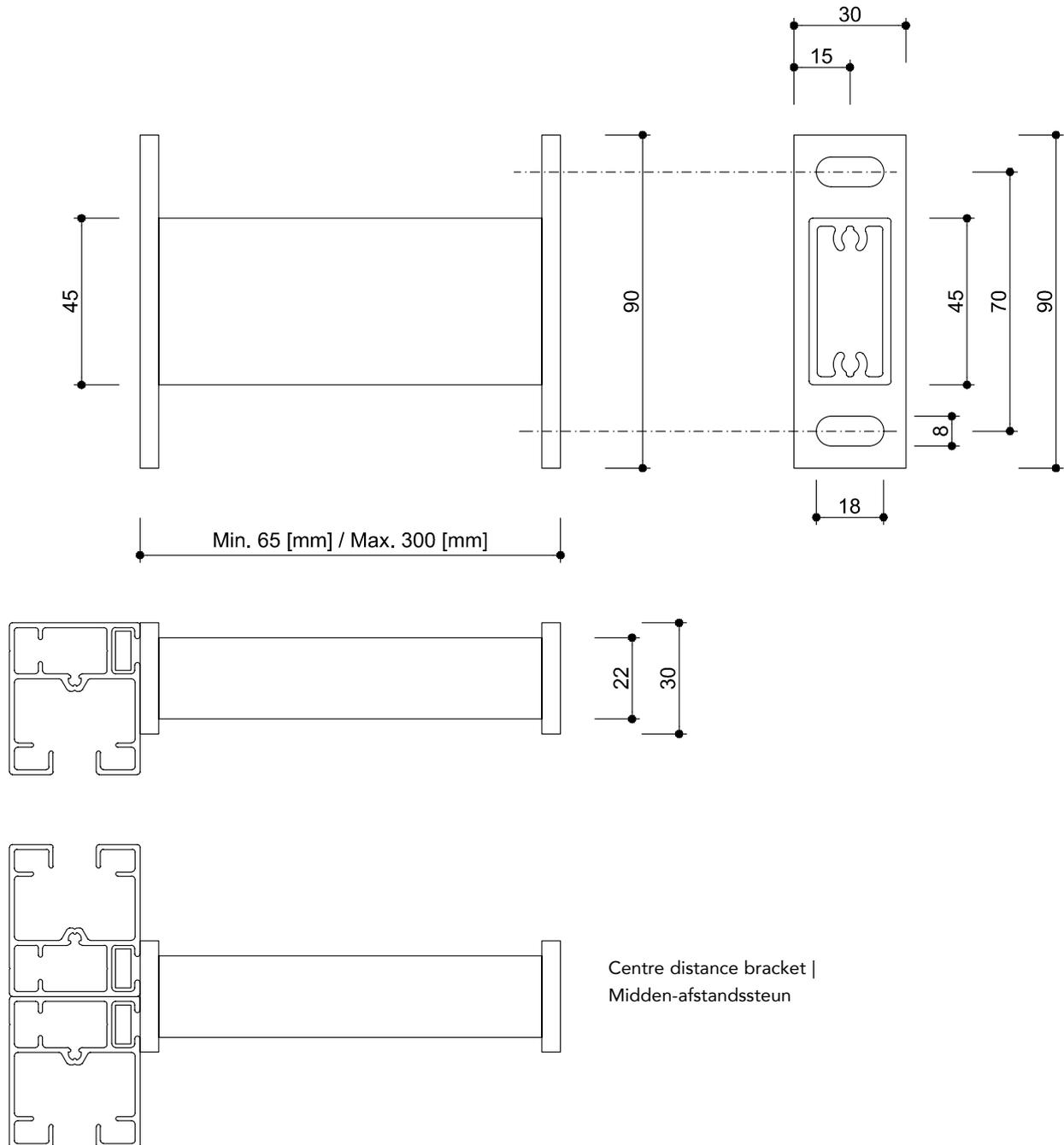

Exploded view

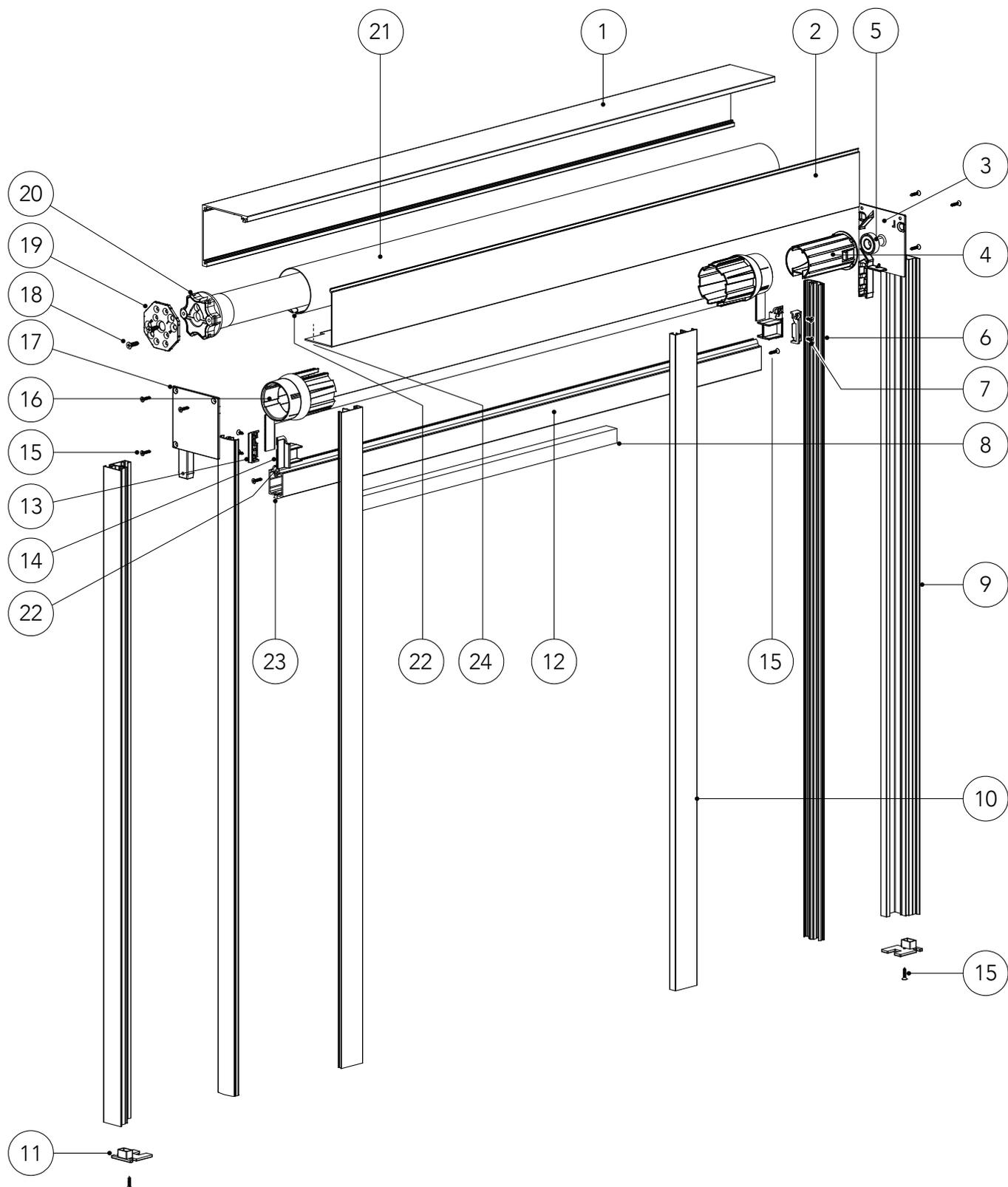

Bill of material

Stuklijst

Item Onderdeel	Description Omschrijving	Quantity Hoeveelheid
1	Top cover Bovenkap	1
2	Bottom cover Onderkap	1
3	Side cap - RIGHT Zijkap - RECHTS	1
4	Bearing filling tube Lagerprop	1
5	Bearing 28 axis 12 mm Precisielager 28 gat 12 mm	1
6	PVC fabric guide Geleidersprofiel kunststof	1
7	Din 7982 self-tapping zelftappend 3,5x10 (for 13)	4
8	Weight bottom bar Verzwaringstaf	1
9	Back profile guide Achterprofiel zijgeleider	2
10	Front profile guide Voorprofiel zijgeleider	2
11	Endcap guide Eindstop zijgeleider	2
12	Bottom bar Onderlijst	1
13	Endcap bottom bar Eindstop onderlijst	2
14	Endcap bottom bar insert Eindstop onderlijst insert	2
15	Din 7982 self-tapping zelftappend 3,5x16 (for 3)	6
	Din 7982 self-tapping zelftappend 3,5x16 (for 11)	2
	Din 7982 self-tapping zelftappend 3,5x16 (for 13/14)	2 / 4
16	Adapter	2
17	Side cap - LEFT Zijkap - LINKS	1
18	Motor screw Motor schroef (for 20)	2
19	Motorconnection Motorplaat	1
20	Motor	1
21	Tube Doekbuis	1
22	Nylon fabric string Doekpees	1
23	Brush Borstel	1
24	Din 7981C self-tapping zelftappend 3.5X6.5 (for 2)	2

Parts list

Onderdelenlijst

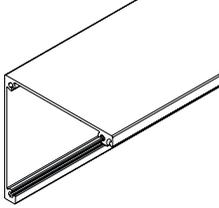
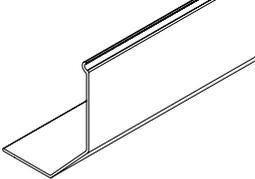
Part Onderdeel	Part No. Art.nr	Description Omschrijving	Length in m ¹ Unit
LENGTHS LENGTES			
1 		Top cover XS Bovenkap XS	7,0 m ¹
	ART-008265	mill finish onbewerkt	
	ART-008266	white wit	
	ART-008267	ivory ivoor - RAL 9001	
	ART-008268	anodized technisch zilver	
	ART-008269	anthracite antraciet - RAL 7016	
	ART-008270	anthracite textured paint antraciet structuurlak - VS716	
ART-031187	black textured paint zwart structuurlak - VS 905		
2 		Bottom cover XS Type 40 Onderkap XS Type 40	7,0 m ¹
	ART-008274	mill finish onbewerkt	
	ART-008275	white wit	
	ART-008276	ivory ivoor - RAL 9001	
	ART-008277	anodized technisch zilver	
	ART-008278	anthracite antraciet - RAL 7016	
	ART-008279	anthracite textured paint antraciet structuurlak - VS716	
ART-031188	black textured paint zwart structuurlak - VS 905		

Parts list

Onderdelenlijst

Part Onderdeel	Part No. Art.nr	Description Omschrijving	Length in m' Unit
-------------------	--------------------	-----------------------------	----------------------

PARTS | ONDERDELEN

3



Part No. Art.nr	Description Omschrijving
ART-025660	mill finish onbewerkt
ART-025661	white wit
ART-025662	ivory ivoor - RAL 9001
ART-025663	grey grijs - RAL 7035
ART-025664	anthracite antraciet - RAL 7016
ART-025665	anthracite textured paint antraciet structuurlak - VS716
ART-031138	black textured paint zwart structuurlak - VS 905

17

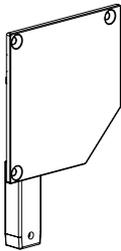

Part No. Art.nr	Description Omschrijving
ART-025666	mill finish onbewerkt
ART-025667	white wit
ART-025668	ivory ivoor - RAL 9001
ART-025669	grey grijs - RAL 7035
ART-025670	anthracite antraciet - RAL 7016
ART-025671	anthracite textured paint antraciet structuurlak - VS716
ART-031139	black textured paint zwart structuurlak - VS 905

Parts list

Onderdelenlijst

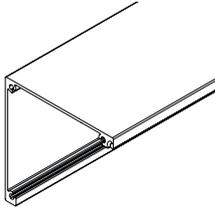
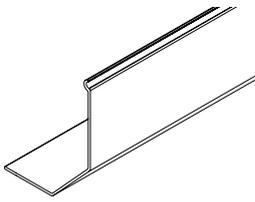
Part Onderdeel	Part No. Art.nr	Description Omschrijving	Length in m ¹ Unit
LENGTES LENGTES			
1 		Top cover S Bovenkap S	7,0 m ¹
	ART-008294	mill finish onbewerkt	
	ART-008295	white wit	
	ART-008296	ivory ivoor - RAL 9001	
	ART-008297	anodized technisch zilver	
	ART-008298	anthracite antraciet - RAL 7016	
	ART-008299	anthracite textured paint antraciet structuurlak - VS716	
ART-031190	black textured paint zwart structuurlak - VS 905		
2 		Bottom cover S Type 40 Onderkap S Type 40	7,0 m ¹
	ART-008305	mill finish onbewerkt	
	ART-008306	white wit	
	ART-008307	ivory ivoor - RAL 9001	
	ART-008308	anodized technisch zilver	
	ART-008309	anthracite antraciet - RAL 7016	
	ART-008310	anthracite textured paint antraciet structuurlak - VS716	
ART-031191	black textured paint zwart structuurlak - VS 905		

Parts list

Onderdelenlijst

Part Onderdeel	Part No. Art.nr	Description Omschrijving	Length in m' Unit
-------------------	--------------------	-----------------------------	----------------------

PARTS | ONDERDELEN

3



Part No. Art.nr	Description Omschrijving
ART-025684	mill finish onbewerkt
ART-025685	white wit
ART-025686	ivory ivoor - RAL 9001
ART-025687	grey grijs - RAL 7035
ART-025688	anthracite antraciet - RAL 7016
ART-025689	anthracite textured paint antraciet structuurlak - VS716
ART-031142	black textured paint zwart structuurlak - VS 905

Side cap S Type 40 - RIGHT | Zijkap S Type 40 - RECHTS

17

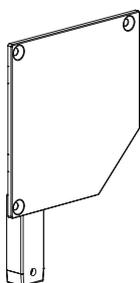

Part No. Art.nr	Description Omschrijving
ART-025690	mill finish onbewerkt
ART-025691	white wit
ART-025692	ivory ivoor - RAL 9001
ART-025693	grey grijs - RAL 7035
ART-025694	anthracite antraciet - RAL 7016
ART-025695	anthracite textured paint antraciet structuurlak - VS716
ART-031143	black textured paint zwart structuurlak - VS 905

Side cap S Type 40 - LEFT | Zijkap S Type 40 - LINKS

Parts list

Onderdelenlijst

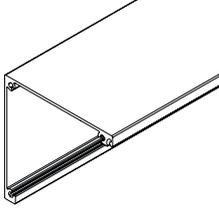
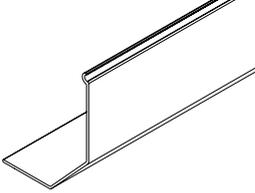
Part Onderdeel	Part No. Art.nr	Description Omschrijving	Length in m ¹ Unit
LENGTHS LENGTES			
1 		Top cover M Bovenkap M	7,0 m ¹
	ART-025757	mill finish onbewerkt	
	ART-025758	white wit	
	ART-025759	ivory ivoor - RAL 9001	
	ART-025760	anodized technisch zilver	
	ART-025761	anthracite antraciet - RAL 7016	
	ART-025762	anthracite textured paint antraciet structuurlak - VS716	
	ART-031181	black textured paint zwart structuurlak - VS 905	
2 		Bottom cover M Type 40 Onderkap M Type 40	7,0 m ¹
	ART-025763	mill finish onbewerkt	
	ART-025764	white wit	
	ART-025765	ivory ivoor - RAL 9001	
	ART-025766	anodized technisch zilver	
	ART-025767	anthracite antraciet - RAL 7016	
	ART-025768	anthracite textured paint antraciet structuurlak - VS716	
	ART-031182	black textured paint zwart structuurlak - VS 905	

Parts list

Onderdelenlijst

Part Onderdeel	Part No. Art.nr	Description Omschrijving	Length in m' Unit
-------------------	--------------------	-----------------------------	----------------------

PARTS | ONDERDELEN

3



Part No. Art.nr	Description Omschrijving
ART-025708	mill finish onbewerkt
ART-025709	white wit
ART-025710	ivory ivoor - RAL 9001
ART-025711	grey grijs - RAL 7035
ART-025712	anthracite antraciet - RAL 7016
ART-025713	anthracite textured paint antraciet structuurlak - VS716
ART-031146	black textured paint zwart structuurlak - VS 905

Side cap M Type 40 - RIGHT | Zijkap M Type 40 - RECHTS

17

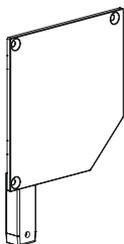

Part No. Art.nr	Description Omschrijving
ART-025714	mill finish onbewerkt
ART-025715	white wit
ART-025716	ivory ivoor - RAL 9001
ART-025717	grey grijs - RAL 7035
ART-025718	anthracite antraciet - RAL 7016
ART-025719	anthracite textured paint antraciet structuurlak - VS716
ART-031147	black textured paint zwart structuurlak - VS 905

Side cap M Type 40 - LEFT | Zijkap M Type 40 - LINKS

Parts list

Onderdelenlijst

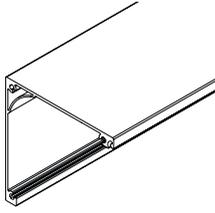
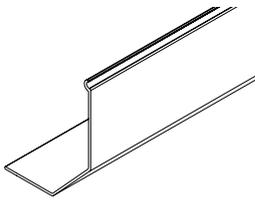
Part Onderdeel	Part No. Art.nr	Description Omschrijving	Length in m ¹ Unit
LENGTHS LENGTES			
1 		Top cover L Type 40 Bovenkap L Type 40	7,0 m ¹
	ART-025775	mill finish onbewerkt	
	ART-025776	white wit	
	ART-025777	ivory ivoor - RAL 9001	
	ART-025778	anodized technisch zilver	
	ART-025779	anthracite antraciet - RAL 7016	
	ART-025780	anthracite textured paint antraciet structuurlak - VS716	
ART-031184	black textured paint zwart structuurlak - VS 905		
2 		Bottom cover L Type 40 Onderkap L Type 40	7,0 m ¹
	ART-025781	mill finish onbewerkt	
	ART-025782	white wit	
	ART-025783	ivory ivoor - RAL 9001	
	ART-025784	anodized technisch zilver	
	ART-025785	anthracite antraciet - RAL 7016	
	ART-025786	anthracite textured paint antraciet structuurlak - VS716	
ART-031185	black textured paint zwart structuurlak - VS 905		

Parts list

Onderdelenlijst

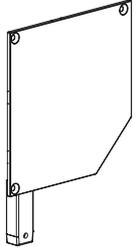
Part Onderdeel	Part No. Art.nr	Description Omschrijving	Length in m' Unit
PARTS ONDERDELEN			
3 		Side cap L Type 40 - RIGHT Zijkap L Type 40 - RECHTS	
	ART-025732	mill finish onbewerkt	
	ART-025733	white wit	
	ART-025734	ivory ivoor - RAL 9001	
	ART-025735	grey grijs - RAL 7035	
	ART-025736	anthracite antraciet - RAL 7016	
	ART-025737	anthracite textured paint antraciet structuurlak - VS716	
ART-031150	black textured paint zwart structuurlak - VS 905		
17 		Side cap L Type 40 - LEFT Zijkap L Type 40 - LINKS	
	ART-025738	mill finish onbewerkt	
	ART-025739	white wit	
	ART-025740	ivory ivoor - RAL 9001	
	ART-025741	grey grijs - RAL 7035	
	ART-025742	anthracite antraciet - RAL 7016	
	ART-025743	anthracite textured paint antraciet structuurlak - VS716	
ART-031151	black textured paint zwart structuurlak - VS 905		

Parts list

Onderdelenlijst

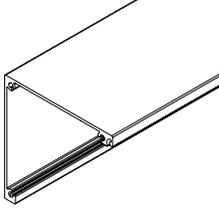
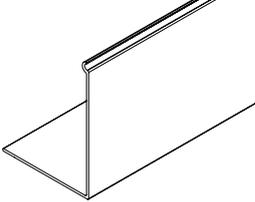
Part Onderdeel	Part No. Art.nr	Description Omschrijving	Length in m ¹ Unit
LENGTHS LENGTES			
1 		Top cover XS Bovenkap XS	7,0 m ¹
	ART-008265	mill finish onbewerkt	
	ART-008266	white wit	
	ART-008267	ivory ivoor - RAL 9001	
	ART-008268	anodized technisch zilver	
	ART-008269	anthracite antraciet - RAL 7016	
	ART-008270	anthracite textured paint antraciet structuurlak - VS716	
ART-031187	black textured paint zwart structuurlak - VS 905		
2 		Bottom cover XS Type 42 Onderkap XS Type 42	7,0 m ¹
	ART-008282	mill finish onbewerkt	
	ART-008283	white wit	
	ART-008284	ivory ivoor - RAL 9001	
	ART-008285	anodized technisch zilver	
	ART-008286	anthracite antraciet - RAL 7016	
	ART-008287	anthracite textured paint antraciet structuurlak - VS716	
ART-031189	black textured paint zwart structuurlak - VS 905		

Parts list

Onderdelenlijst

Part Onderdeel	Part No. Art.nr	Description Omschrijving	Length in m' Unit
-------------------	--------------------	-----------------------------	----------------------

PARTS | ONDERDELEN

3



Part No. Art.nr	Description Omschrijving
ART-025672	mill finish onbewerkt
ART-025673	white wit
ART-025674	ivory ivoor - RAL 9001
ART-025675	grey grijs - RAL 7035
ART-025676	anthracite antraciet - RAL 7016
ART-025677	anthracite textured paint antraciet structuurlak - VS716
ART-031140	black textured paint zwart structuurlak - VS 905

17

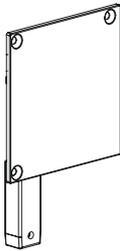

Part No. Art.nr	Description Omschrijving
ART-025678	mill finish onbewerkt
ART-025679	white wit
ART-025680	ivory ivoor - RAL 9001
ART-025681	grey grijs - RAL 7035
ART-025682	anthracite antraciet - RAL 7016
ART-025683	anthracite textured paint antraciet structuurlak - VS716
ART-031141	black textured paint zwart structuurlak - VS 905

Parts list

Onderdelenlijst

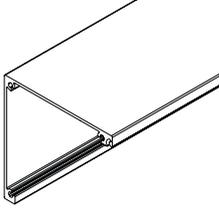
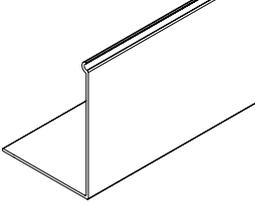
Part Onderdeel	Part No. Art.nr	Description Omschrijving	Length in m ¹ Unit
LENGTES LENGTES			
1 		Top cover S Bovenkap S	7,0 m ¹
	ART-008294	mill finish onbewerkt	
	ART-008295	white wit	
	ART-008296	ivory ivoor - RAL 9001	
	ART-008297	anodized technisch zilver	
	ART-008298	anthracite antraciet - RAL 7016	
	ART-008299	anthracite textured paint antraciet structuurlak - VS716	
	ART-031190	black textured paint zwart structuurlak - VS 905	
2 		Bottom cover S Type 42 Onderkap S Type 42	7,0 m ¹
	ART-008316	mill finish onbewerkt	
	ART-008317	white wit	
	ART-008318	ivory ivoor - RAL 9001	
	ART-008319	anodized technisch zilver	
	ART-008320	anthracite antraciet - RAL 7016	
	ART-008321	anthracite textured paint antraciet structuurlak - VS716	
	ART-031192	black textured paint zwart structuurlak - VS 905	

Parts list

Onderdelenlijst

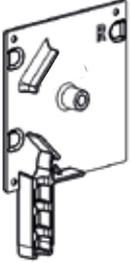
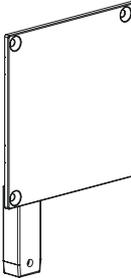
Part Onderdeel	Part No. Art.nr	Description Omschrijving	Length in m' Unit
PARTS ONDERDELEN			
3 		Side cap S Type 42 - RIGHT Zijkap S Type 42 - RECHTS	
	ART-025696	mill finish onbewerkt	
	ART-025697	white wit	
	ART-025698	ivory ivoor - RAL 9001	
	ART-025699	grey grijs - RAL 7035	
	ART-025700	anthracite antraciet - RAL 7016	
	ART-025701	anthracite textured paint antraciet structuurlak - VS716	
ART-031144	black textured paint zwart structuurlak - VS 905		
17 		Side cap S Type 42 - LEFT Zijkap S Type 42 - LINKS	
	ART-025702	mill finish onbewerkt	
	ART-025703	white wit	
	ART-025704	ivory ivoor - RAL 9001	
	ART-025705	grey grijs - RAL 7035	
	ART-025706	anthracite antraciet - RAL 7016	
	ART-025707	anthracite textured paint antraciet structuurlak - VS716	
ART-031145	black textured paint zwart structuurlak - VS 905		

Parts list

Onderdelenlijst

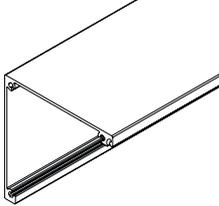
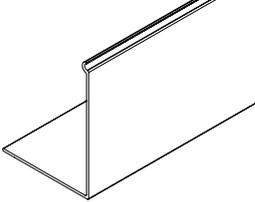
Part Onderdeel	Part No. Art.nr	Description Omschrijving	Length in m ¹ Unit
LENGTHS LENGTES			
1 		Top cover M Bovenkap M	7,0 m ¹
	ART-025757	mill finish onbewerkt	
	ART-025758	white wit	
	ART-025759	ivory ivoor - RAL 9001	
	ART-025760	anodized technisch zilver	
	ART-025761	anthracite antraciet - RAL 7016	
	ART-025762	anthracite textured paint antraciet structuurlak - VS716	
	ART-031181	black textured paint zwart structuurlak - VS 905	
2 		Bottom cover M Type 42 Onderkap M Type 42	7,0 m ¹
	ART-025769	mill finish onbewerkt	
	ART-025770	white wit	
	ART-025771	ivory ivoor - RAL 9001	
	ART-025772	anodized technisch zilver	
	ART-025773	anthracite antraciet - RAL 7016	
	ART-025774	anthracite textured paint antraciet structuurlak - VS716	
	ART-031183	black textured paint zwart structuurlak - VS 905	

Parts list

Onderdelenlijst

Part Onderdeel	Part No. Art.nr	Description Omschrijving	Length in m' Unit
-------------------	--------------------	-----------------------------	----------------------

PARTS | ONDERDELEN

3

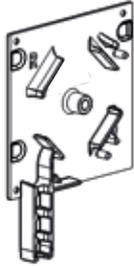

Part No. Art.nr	Description Omschrijving
ART-025720	mill finish onbewerkt
ART-025721	white wit
ART-025722	ivory ivoor - RAL 9001
ART-025723	grey grijs - RAL 7035
ART-025724	anthracite antraciet - RAL 7016
ART-025725	anthracite textured paint antraciet structuurlak - VS716
ART-031148	black textured paint zwart structuurlak - VS 905

17

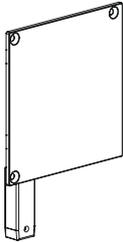

Part No. Art.nr	Description Omschrijving
ART-025726	mill finish onbewerkt
ART-025727	white wit
ART-025728	ivory ivoor - RAL 9001
ART-025729	grey grijs - RAL 7035
ART-025730	anthracite antraciet - RAL 7016
ART-025731	anthracite textured paint antraciet structuurlak - VS716
ART-031149	black textured paint zwart structuurlak - VS 905

Parts list

Onderdelenlijst

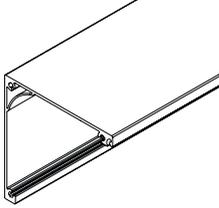
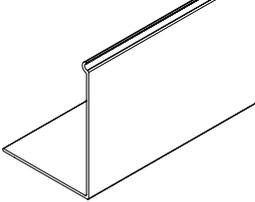
Part Onderdeel	Part No. Art.nr	Description Omschrijving	Length in m ¹ Unit
LENGTHS LENGTES			
1 		Top cover L Bovenkap L	7,0 m ¹
	ART-025775	mill finish onbewerkt	
	ART-025776	white wit	
	ART-025777	ivory ivoor - RAL 9001	
	ART-025778	anodized technisch zilver	
	ART-025779	anthracite antraciet - RAL 7016	
	ART-025780	anthracite textured paint antraciet structuurlak - VS716	
ART-031184	black textured paint zwart structuurlak - VS 905		
2 		Bottom cover L Type 42 Onderkap L Type 42	7,0 m ¹
	ART-025787	mill finish onbewerkt	
	ART-025788	white wit	
	ART-025789	ivory ivoor - RAL 9001	
	ART-025790	anodized technisch zilver	
	ART-025791	anthracite antraciet - RAL 7016	
	ART-025792	anthracite textured paint antraciet structuurlak - VS716	
ART-031186	black textured paint zwart structuurlak - VS 905		

Parts list

Onderdelenlijst

Part Onderdeel	Part No. Art.nr	Description Omschrijving	Length in m' Unit
-------------------	--------------------	-----------------------------	----------------------

PARTS | ONDERDELEN

3



Part No. Art.nr	Description Omschrijving
ART-025744	mill finish onbewerkt
ART-025745	white wit
ART-025746	ivory ivoor - RAL 9001
ART-025747	grey grijs - RAL 7035
ART-025748	anthracite antraciet - RAL 7016
ART-025749	anthracite textured paint antraciet structuurlak - VS716
ART-031152	black textured paint zwart structuurlak - VS 905

Side cap L Type 42 - RIGHT | Zijkap L Type 42 - RECHTS

17

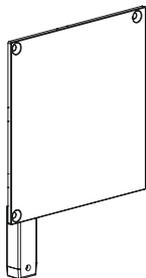

Part No. Art.nr	Description Omschrijving
ART-025750	mill finish onbewerkt
ART-025751	white wit
ART-025752	ivory ivoor - RAL 9001
ART-025753	grey grijs - RAL 7035
ART-025754	anthracite antraciet - RAL 7016
ART-025755	anthracite textured paint antraciet structuurlak - VS716
ART-031153	black textured paint zwart structuurlak - VS 905

Side cap L Type 42 - LEFT | Zijkap L Type 42 - LINKS

Parts list

Onderdelenlijst

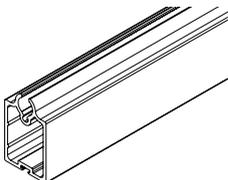
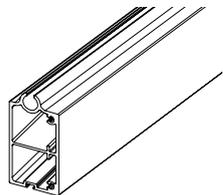
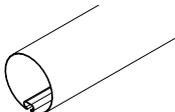
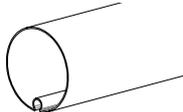
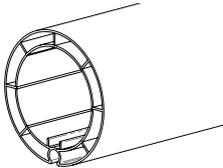
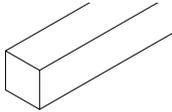
Part Onderdeel	Part No. Art.nr	Description Omschrijving	Length in m ¹ Unit
LENGTHS LENGTES			
12 	Bottom bar S Onderlijst S (standard)		
	ART-025812	mill finish onbewerkt	6,7 m ¹
	ART-025813	white wit	6,7 m ¹
	ART-025814	ivory ivoor - RAL 9001	7,0 m ¹
	ART-025815	anodized technisch zilver	7,0 m ¹
	ART-025816	anthracite antraciet - RAL 7016	7,0 m ¹
	ART-025817	anthracite textured paint antraciet structuurlak - VS716	7,0 m ¹
ART-031163	black textured paint zwart structuurlak - VS 905	7,0 m ¹	
12 	Bottom bar L Onderlijst L		7,0 m ¹
	ART-025818	mill finish onbewerkt	
	ART-025819	white wit	
	ART-025820	ivory ivoor - RAL 9001	
	ART-025821	anodized technisch zilver	
	ART-025822	anthracite antraciet - RAL 7016	
	ART-025823	anthracite textured paint antraciet structuurlak - VS716	
ART-031164	black textured paint zwart structuurlak - VS 905		
21 	ART-032495	V500 Tube ø63 V500 Doekbuis ø63 - 1 mm mill finish onbewerkt (ART-008356 V100 Doekbuis ø63 -0,9 mm)	7,5 m ¹
	21 	ART-008357	Tube ø78 Doekbuis ø78 - 1,25 mm galvanized verzinkt
21 		ART-008231	Tube ø100 Doekbuis ø100 aluminium
	8 	ART-036318	Weight bottom bar Verzwarringsstaf 20x20mm galvanized verzinkt
ART-025830		galvanized verzinkt	6,0 m ¹
22 	ART-028267	PVC pipe PVC buis - 16mm	4,0 m ¹
	ART-005359	Nylon fabric string Doekpees - 6 mm - for bottom bar voor onderlijst - for tube doekbuis ø78/ø100	

Parts list

Onderdelenlijst

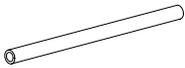
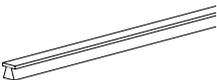
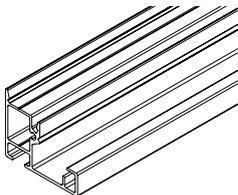
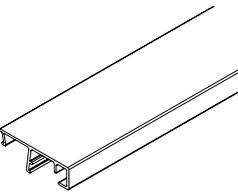
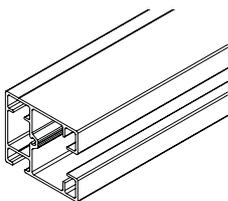
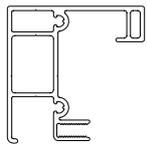
Part Onderdeel	Part No. Art.nr	Description Omschrijving	Length in m ¹ Unit
22	 ART-007658	Nylon fabric string Doekpees - 5 mm - for tube doekbuis ø63	
23	 ART-007734	Brush mohair Borstel mohair 8 mm - back rug 5.1 mm	
HEIGHTS HOOGTES			
9	 ART-025806 ART-025807 ART-025808 ART-025809 ART-025810 ART-025811 ART-031162	Back profile two-part guide Achterprofiel zijgeleider 2-delig mill finish onbewerkt white wit ivory ivoor - RAL 9001 anodized technisch zilver anthracite antraciet - RAL 7016 anthracite textured paint antraciet structuurlak - VS716 black textured paint zwart structuurlak - VS 905	7,0 m ¹
10	 ART-025800 ART-025801 ART-025802 ART-025803 ART-025804 ART-025805 ART-031161	Front profile two-part guide CLICK Voorprofiel zijgeleider KLIK mill finish onbewerkt white wit ivory ivoor - RAL 9001 anodized technisch zilver anthracite antraciet - RAL 7016 anthracite textured paint antraciet structuurlak - VS716 black textured paint zwart structuurlak - VS 905	7,0 m ¹
	 ART-025794 ART-025795 ART-025796 ART-025797 ART-025798 ART-025799 ART-031160	Single guide profile Zijgeleider 1-delig mill finish onbewerkt white wit ivory ivoor - RAL 9001 anodized technisch zilver anthracite antraciet - RAL 7016 anthracite textured paint antraciet structuurlak - VS716 black textured paint zwart structuurlak - VS 905	7,0 m ¹ 7,0 m ¹ 7,0 m ¹ 6,7 m ¹ 6,7 m ¹ 7,0 m ¹ 7,0 m ¹
	 ART-033202 ART-033207 ART-033201 ART-033204 ART-033203 ART-033205 ART-033206	Back profile two-part guide SCREW, suitable for verandas Achterprofiel zijgeleider 2-delig SCHROEF, toepasbaar bij verandas mill finish onbewerkt white wit ivory ivoor - RAL 9001 anodized technisch zilver anthracite antraciet - RAL 7016 anthracite textured paint antraciet structuurlak - VS716 black textured paint zwart structuurlak - VS 905	7,0 m ¹

Parts list

Onderdelenlijst

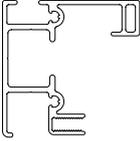
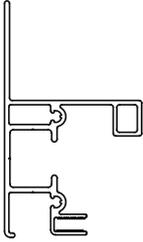
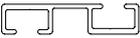
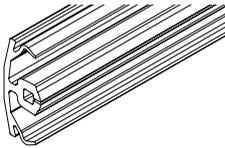
Part Onderdeel	Part No. Art.nr	Description Omschrijving	Length in m ¹ Unit
		Back profile two-part guide SCREW with cable entry Achterprofiel zijgeleider 2-delig SCHROEF met kabeldoorgang	7,0 m ¹
	ART-043477	mill finish onbewerkt	
	ART-043482	white wit	
	ART-043476	ivory ivoor - RAL 9001	
	ART-043479	anodized technisch zilver	
	ART-043478	anthracite antraciet - RAL 7016	
	ART-043480 ART-043481	anthracite textured paint antraciet structuurlak - VS716 black textured paint zwart structuurlak - VS 905	
		Front profile two-part guide SCREW, suitable for verandas Voorprofiel zijgeleider 2-delig SCHROEF, toepasbaar bij verandas	7,0 m ¹
	ART-043484	mill finish onbewerkt	
	ART-043489	white wit	
	ART-043483	ivory ivoor - RAL 9001	
	ART-043486	anodized technisch zilver	
	ART-043485	anthracite antraciet - RAL 7016	
	ART-043487 ART-043488	anthracite textured paint antraciet structuurlak - VS716 black textured paint zwart structuurlak - VS 905	
		LHTF guide LHTF geleider	7,0 m ¹
	ART-042591	mill finish onbewerkt	
	ART-044356	white wit	
	ART-044357	ivory ivoor - RAL 9001	
	ART-044358	anthracite antraciet - RAL 7016	
	ART-042629 ART-044359	anthracite textured paint antraciet structuurlak - VS716 black textured paint zwart structuurlak - VS 905	
		Filler profile Opvulprofiel	7,0 m ¹
	ART-042590	mill finish onbewerkt	
	ART-044352	white wit	
	ART-044353	ivory ivoor - RAL 9001	
	ART-042628	anthracite antraciet - RAL 7016	
	ART-043487 ART-044355	anthracite textured paint antraciet structuurlak - VS716 black textured paint zwart structuurlak - VS 905	
6		ART-025793 PVC flex inlay Geleiderprofiel kunststof	7,0 m ¹

Parts list

Onderdelenlijst

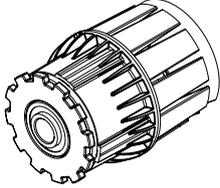
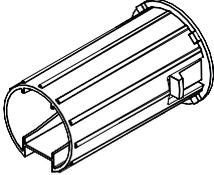
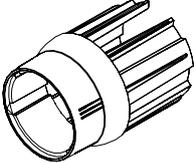
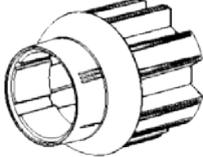
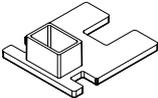
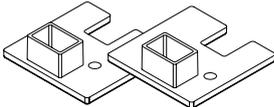
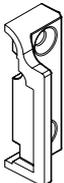
Part Onderdeel	Part No. Art.nr	Description Omschrijving	Length in m' Unit
PARTS ONDERDELEN			
4	ART-044288	Bearing filling tube ø63 Lagerprop ø63 For USP's see page 47 Zie pagina 47 voor USP's	
			
4	ART-028264	Bearing filling tube Lagerprop	
			
5	ART-033324	Bearing 28 axis 12 mm Precisielager 28 gat 12 mm	
			
16	ART-028265	Adapter ø63	
			
16	ART-028266	Adapter ø78	
			
11	ART-028259	Endcap guide Eindstop zijgeleider	
			
	ART-033952	Endcap two-part guide SCREW - LEFT and RIGHT Eindstop zijgeleider 2-delig SCHROEF - LINKS en RECHTS black zwart	
13	ART-028257	Endcap bottom bar S cover Eindstop onderlijst S kap	
			

Parts list

Onderdelenlijst

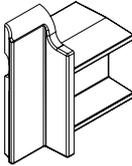
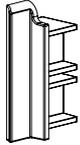
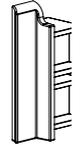
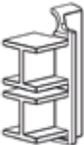
Part Onderdeel	Part No. Art.nr	Description Omschrijving	Length in m' Unit
14 	ART-028258	Endcap bottom bar S insert Eindstop onderlijst S inzet	
	ART-028262	RIGHT RECHTS Endcap bottom bar L cover Eindstop onderlijst L kap	
	ART-028260	LEFT LINKS Endcap bottom bar L cover Eindstop onderlijst L kap	
	ART-028263	RIGHT RECHTS Endcap bottom bar L insert Eindstop onderlijst L insert	
	ART-028261	LEFT LINKS Endcap bottom bar L insert Eindstop onderlijst L insert	
	ART-042688	Fixing clip filler profile Bevestigingsclip opvulprofiel	

DISTANCE BRACKET | AFSTANDSSTEUN

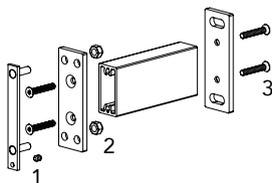

Distance bracket | Afstandssteun
ASSEMBLY | ASSEMBLAGE

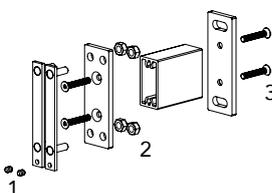

Distance bracket center | Afstandssteun midden
ASSEMBLY | ASSEMBLAGE

Parts list

Onderdelenlijst

Part Onderdeel	Part No. Art.nr	Description Omschrijving	Length in m ¹ Unit
	ART-025646	Distancebracket insert Afstandhouder inzet 11.5x95x3mm mill finish onbewerkt	
	ART-025647 ART-025648 ART-025649 ART-025650 ART-025651 ART-025652 ART-031136	Mounting plate insert Bevestigingsplaat inzet 90x22x5mm mill finish onbewerkt white wit ivory ivoor - RAL 9001 anodized technisch zilver anthracite antraciet - RAL 7016 anthracite textured paint antraciet structuurlak - VS716 black textured paint zwart structuurlak - VS 905	
	ART-025824 ART-025825 ART-025826 ART-025827 ART-025828 ART-025829 ART-031165	Profile distance bracket Profiel afstandsteun mill finish onbewerkt white wit ivory ivoor - RAL 9001 anodized technisch zilver anthracite antraciet - RAL 7016 anthracite textured paint antraciet structuurlak - VS716 black textured paint zwart structuurlak - VS 905	7,0 m ¹
	ART-025653 ART-025654 ART-025655 ART-025656 ART-025657 ART-025658 ART-031137	Mounting plate wall Bevestigingsplaat muur 90x22x5mm mill finish onbewerkt white wit ivory ivoor - RAL 9001 anodized technisch zilver anthracite antraciet - RAL 7016 anthracite textured paint antraciet structuurlak - VS716 black textured paint zwart structuurlak - VS 905	
	ART-030999	(1) Stelschroef - DIN 916 Bzk Ke A2 M5x6	
	ART-025526	(2) Nut Borgmoer - Din 985 A2 M6 RVS	
	ART-032984	(3) Screw Schroef - Din 7500 M A2 5x25 TX	

MOTOR

19

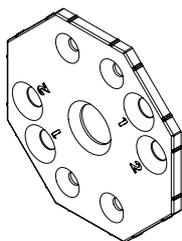

ART-025659

Motorconnection | Motorplaat

Parts list

Onderdelenlijst

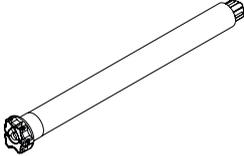
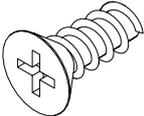
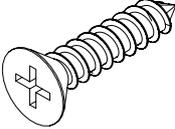
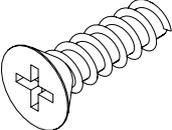
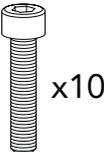
Part Onderdeel	Part No. Art.nr	Description Omschrijving	Length in m' Unit
20		Motor - of your own choice - naar eigen keuze	
			
	ART-043588	V45-SO iMove ring 0,3mm adaption 45mm motor (filling ring for Brel motor opvulring voor Brel motor)	
SCREWS SCHOEVEN			
7	ART-032166	Screw Kunststofschoef 3.5X10 - for mounting endcap bottom bar to endcap insert (4x) - voor montage eindstop onderlijst aan eindstop inzet (4x)	
			
15	ART-025438	Din 7982C self-tapping zelftappend Vkk A2 3.5X16 - for mounting side cap (3x) - voor montage van de zijkap (3x) - for mounting endcap guide (2x) - voor montage eindstop zijgeleider (2x) - for mounting endcap bottom bar to bottom bar (S - 2x) (L - 4x) - voor montage eindstop onderlijst aan onderlijst (S - 2x) (L - 4x)	
			
18		Motor screw Motor schroef - for mounting motor of your choice (2x) - voor montage motor naar eigen keuze (2x)	
			
24	ART-025373	Din 7981C self-tapping zelftappend Ckk A2 3.5X6.5 - for mounting bottom cover to side cap (2x) - voor montage onderkap aan zijkap (2x)	
			
	ART-033806	Assembly set for two-part guide SCREW Bevestigingsset voor zijgeleider 2-delig SCHROEF	x10

Parts list

Onderdelenlijst

Part Onderdeel	Part No. Art.nr	Description Omschrijving	Length in m' Unit
-------------------	--------------------	-----------------------------	----------------------

VARIOUS | OVERIGEN



Part No. Art.nr	Description Omschrijving	Length in m' Unit
	Nylon sealing caps Afdekdopje 10 mm*	8 pieces 8 stuks
ART-000241	white wit	
ART-000242	grey grijs	
ART-000243	brown bruin	
ART-000244	hell beige	
ART-000245	natural naturel (9006)	
ART-000246	cream creme	
ART-000247	red rood	
ART-000248	black zwart	
ART-000249	dark green donkergroen	
ART-000250	steel blue staalblauw	
ART-000251	antracite grey antraciet grijs	
ART-000252	cream white roomwit (9001)	

*only for single guide profiel | alleen voor 1-delige geleider

TOOLS*



Kunststof geleiderprofiel snijder | PVC flex inlay cutter



**V-vorm snijder kunststof geleiderprofiel |
Incision V shape PVC flex inlay**



**Machine voor de insnedes in het kunststof geleiderprofiel |
Machine for incision sides PVC flex inlay**

*De benodigde tools kunnen op aanvraag door Bolbyr® geleverd worden. Prijs op aanvraag.

*The necessary tools can be supplied by Bolbyr® on request. Price on request.

Additional technical information

Aanvullende technische informatie

Part
Onderdeel

Description
Omschrijving

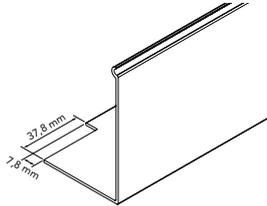

Saw recess

The bottom cover needs to be prepared for the guides.
Depth 7,8 mm and width 37,8 mm

Zagen uitsparing

De onderkap moet voorzien worden van een uitsparing voor de geleiders.
Diepte 7,8 mm en breedte 37,8 mm

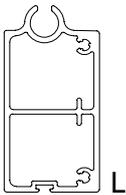

Use of bottom bar L

Starting from a screen width or screen height of 3000 [mm], Bolbyr® advises to use bottom bar L.

Toepassing onderlijst L

Vanaf een screenbreedte of screenhoogte groter dan 3000 [mm] adviseert Bolbyr® onderlijst L toe te passen.

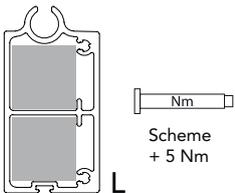

Bottom bar L with weighting

Scheme + 5 Nm!

Onderlijst L met verzwaring

Schema + 5 Nm!

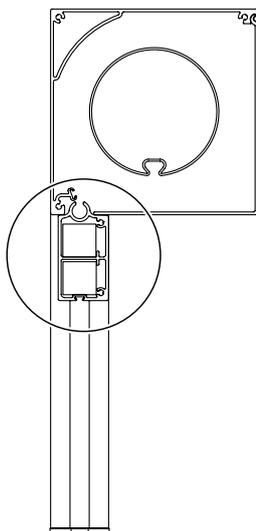

Positioning bottom bar L

Takes into account the correct position of the bottom bar L because it is not symmetrical. The front is deeper than the back.

Positionering onderlijst L

Houdt rekening met de juiste positie van de onderlijst L omdat deze niet symmetrisch is.
De voorzijde is dieper dan de achterzijde.

Additional technical information

Aanvullende technische informatie

Part Onderdeel	Description Omschrijving
-------------------	-----------------------------

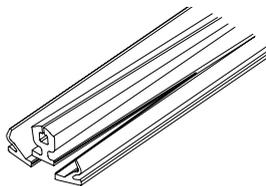

The PVC flex inlay has to be fixed.

In both sides of the Flex inlay an incision of 20 cm must be made so that the ZIP does not break during the up and down movements by strong wind, etcetera.

In addition, a V-shape must be cut at the top of the Koextrusion Inlay so that the ZIP runs smoothly and without problems.

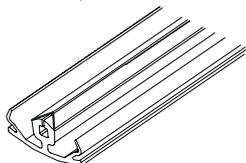

Het kunststof geleiderprofiel moet een bewerking ondergaan.

In beide zijden van de co-extrusie inlay moet een incisie van 20 cm gemaakt worden zodat de rits niet kapot gaat gedurende de op en neer bewegingen door sterke wind, etcetera.

Tevens moet er een V-vorm gesneden worden aan de bovenzijde van de co-extrusie Inlay zodat de ZIP soepel en zonder problemen op en neer loopt.

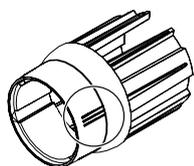

Marks on adapter

Different stripes are highlighted on the adapter. This for the different brand of the motors.

Markering op adapter

Op de adapter zijn verschillende strepen gemarkeerd. Dit voor de verschillende merken motoren.

I = Somfy

II = Nice

III = Extra

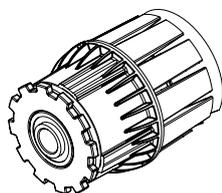

USP's Bearing filling tube ø63

Fabric or motor revision without dismantling

Secures itself in every tube by means of Allen adjustment

Recommended application from 2000 mm wide

Only available for ø63 tube

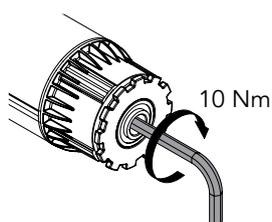

USP's Lagerprop ø63

Revisie doek of motor zonder demontage screen

Zet zich volledig vast in iedere buis door inbus-verstelling

Advies toepassing vanaf 2000 mm breed

Alleen nog beschikbaar voor Buis ø63

BOLBYR®

Bolbyr® B.V. - Magazijnweg 27-29 - 5683 CV Best - Nederland (Netherlands)
T +31 (0)88-9876543 - sales@bolbyr.com - www.bolbyr.com