

BOLBYR



ROLLER SHUTTERS
ROLLUIKEN

HEROAL

EN

NL

Subject to misprints, errors and technical modifications.
Drukfouten, fouten en technische wijzigingen voorbehouden.

29770916HEROAL-EN-NL-240322

Contents

Inhoudsopgave

Technical specifications
Technische specificaties4

Measurements
Maatvoering 5

Shortening sizes
Afkortmaten6

Exploded view10

Bill of material
Stuklijst11

Parts list
Onderdelenlijst.....12

Technical specifications

Technische specificaties

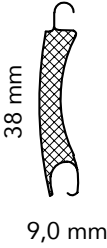
Mini E	
	
Aluminum slat Gemoffelde aluminium lamel	
Weight armor Pantsergewicht	: 4,5 [kg/m2]
Cover width Dekbreedte	: 38 [mm]
Thickness slat Lameldikte	: 9,0 [mm]
Max. surface Max. oppervlakte	: 8 [m2]

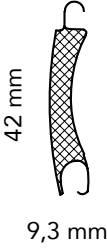
HK842	
	
Aluminum slat Gemoffelde aluminium lamel	
Weight armor Pantsergewicht	: 3,9 [kg/m2]
Cover width Dekbreedte	: 42 [mm]
Thickness slat Lameldikte	: 9,3 [mm]
Max. surface Max. oppervlakte	: 7 [m2]

Measurements

Maatvoering

Cross section | Doorsnede
 Sizes | Maten in mm

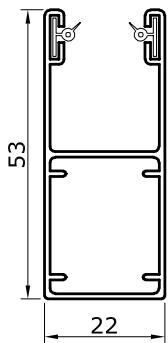

HTF

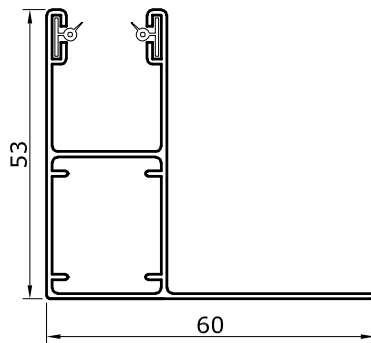

LHTF

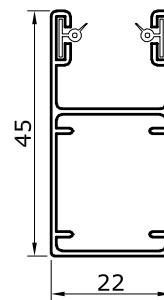

HF

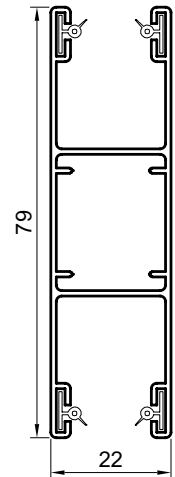

MHTF

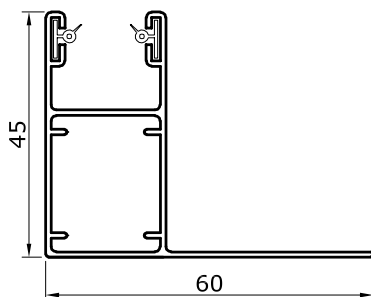

LHF

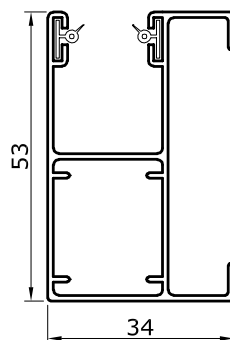

FHTF/12

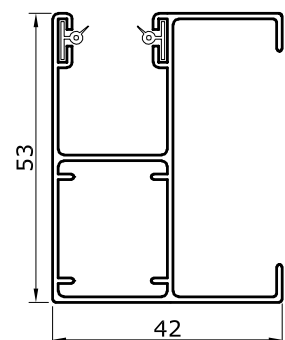

FHTF/20

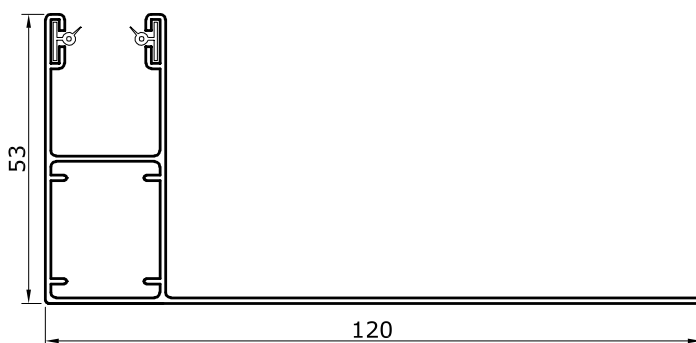

BLHTF/120

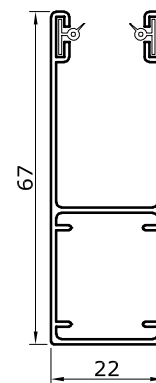

HTF/67

Scheme

Schema

Boxsize Kapmaat		
Total height Totale hoogte [mm]	Heroal Mini E	Heroal HK842
1000	150	150
1100		
1200		
1300		
1400	165	165
1500		
1600		
1700	180	180
1800		
1900		
2000		
2100		
2200	205	205
2300		
2400		
2500		
2600		
2700		
2800		
2900		
3000		
3100		
3200		
3300		
3400		
3500		
3600		
3700		
3800		
3900		
4000		

Tabel is op basis van as 8K60

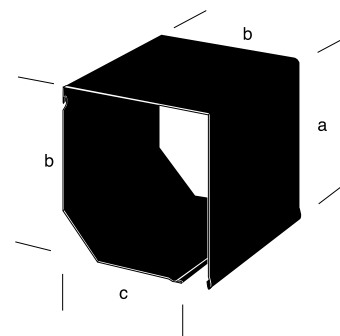

Boxsize Kapmaat			
Type	Size Afmeting a in [mm]	Size Afmeting b in [mm]	Size Afmeting c in [mm]
150/45°	154	150	114
165/45°	169	165	125
180/45°	183	180	147
205/45°	210	205	171

Scheme

Schema

HEROAL MINI E

Minimal required 
 Minimaal benodigd 

Boxsize Kapmaat [mm]	Height guide Lichthoogte	Total height Totale hoogte	Width Breedte [mm] ←→													
			1000	1100	1200	1300	1400	1500	1600	1700	1800	1900	2000	2100	2200	2300
150	850	1000	6	6	6	6	6	6	6	6	6	6	6	6	6	6
	950	1100	6	6	6	6	6	6	6	6	6	6	6	6	6	6
	1050	1200	6	6	6	6	6	6	6	6	6	6	6	6	6	6
	1150	1300	6	6	6	6	6	6	6	6	6	6	6	6	6	6
165	1235	1400	6	6	6	6	6	6	6	6	6	6	6	6	6	6
	1335	1500	6	6	6	6	6	6	6	6	6	6	6	6	6	8
	1435	1600	6	6	6	6	6	6	6	6	6	6	6	6	8	8
180	1520	1700	6	6	6	6	6	6	6	6	6	6	8	8	8	10
	1620	1800	6	6	6	6	6	6	6	6	6	8	8	10	10	10
	1720	1900	6	6	6	6	6	6	6	6	8	8	10	10	10	10
	1820	2000	6	6	6	6	6	6	6	8	8	10	10	10	10	15
	1920	2100	6	6	6	6	6	6	8	8	10	10	10	10	15	15
205	1995	2200	6	6	6	6	6	8	8	10	10	10	10	10	15	15
	2095	2300	6	6	6	6	8	8	10	10	10	15	15	15	15	15
	2195	2400	6	6	6	8	8	10	10	10	15	15	15	15	15	15
	2295	2500	6	6	8	8	10	10	10	10	15	15	15	15	15	15
	2395	2600	6	6	8	10	10	10	10	15	15	15	15	15	15	15
	2495	2700	6	8	8	10	10	10	15	15	15	15	15	15	15	15
	2595	2800	6	8	10	10	10	15	15	15	15	15	15	15	15	20
	2695	2900	8	8	10	10	10	15	15	15	15	15	15	15	20	20

Boxsize Kapmaat [mm]	Height guide Lichthoogte	Total height Totale hoogte	Width Breedte [mm] ←→													
			2400	2500	2600	2700	2800	2900	3000	3100	3200	3300	3400	3500	3600	3700
150	850	1000	6	6	6	6	6	6	6	6	6	6	6	6	6	6
	950	1100	6	6	6	6	6	6	6	6	6	8	8	8	8	8
	1050	1200	6	6	6	6	8	8	8	8	8	8	10	10	10	10
	1150	1300	6	6	8	8	8	8	8	8	10	10	10	10	10	10
165	1235	1400	6	8	8	8	10	10	10	10	10	10	10	10	10	10
	1335	1500	8	8	10	10	10	10	10	10	10	15	15	15	15	15
	1435	1600	10	10	10	10	10	10	15	15	15	15	15	15	15	15
180	1520	1700	10	10	10	10	15	15	15	15	15	15	15	15	15	15
	1620	1800	10	10	10	15	15	15	15	15	15	15	15	15	15	15
	1720	1900	10	15	15	15	15	15	15	15	15	15	15	15	15	15
	1820	2000	15	15	15	15	15	15	15	15	15	15	15	20	20	20
	1920	2100	15	15	15	15	15	15	15	15	15	20	20	20	20	20
205	1995	2200	15	15	15	15	15	15	15	20	20	20	20	20	20	20
	2095	2300	15	15	15	15	15	20	20	20	20	20	20	20	20	20
	2195	2400	15	15	15	15	20	20	20	20	20	20	20	20	20	20
	2295	2500	15	15	20	20	20	20	20	20	20	20	20	25	25	25
	2395	2600	15	20	20	20	20	20	20	20	20	25	25	25	25	25
	2495	2700	20	20	20	20	20	20	20	20	25	25	25	25	25	30
	2595	2800	20	20	20	20	20	20	25	25	25	25	25	25	30	30
	2695	2900	20	20	20	20	20	25	25	25	25	25	25	25	30	30

Scheme

Schema

HEROAL HK842

Minimal required
 Minimaal benodigd

Boxsize Kapmaat [mm]	Height guide Lichthoogte	Total height Totale hoogte	Width Breedte [mm] ←→											
			1000	1100	1200	1300	1400	1500	1600	1700	1800	1900	2000	2100
150	850	1000	6	6	6	6	6	6	6	6	6	6	6	6
	950	1100	6	6	6	6	6	6	6	6	6	6	6	6
	1050	1200	6	6	6	6	6	6	6	6	6	6	6	6
	1150	1300	6	6	6	6	6	6	6	6	6	6	6	6
165	1235	1400	6	6	6	6	6	6	6	6	6	6	6	6
	1335	1500	6	6	6	6	6	6	6	6	6	6	6	6
	1435	1600	6	6	6	6	6	6	6	6	6	6	6	6
180	1520	1700	6	6	6	6	6	6	6	6	6	6	8	8
	1620	1800	6	6	6	6	6	6	6	6	6	8	8	10
	1720	1900	6	6	6	6	6	6	6	6	8	8	10	10
	1820	2000	6	6	6	6	6	6	6	6	8	8	10	10
	1920	2100	6	6	6	6	6	6	6	8	8	10	10	10
205	1995	2200	6	6	6	6	6	8	8	10	10	10	10	15
	2095	2300	6	6	6	6	8	8	10	10	10	15	15	15
	2195	2400	6	6	6	8	8	10	10	10	15	15	15	15
	2295	2500	6	6	8	8	10	10	10	10	15	15	15	15
	2395	2600	6	6	8	10	10	10	10	15	15	15	15	15
	2495	2700	6	8	8	10	10	10	15	15	15	15	15	15
	2595	2800	6	8	10	10	10	15	15	15	15	15	15	15
	2695	2900	8	8	10	10	10	15	15	15	15	15	15	15
	2795	3000	8	10	10	10	15	15	15	15	15	15	15	20

Boxsize Kapmaat [mm]	Height guide Lichthoogte	Total height Totale hoogte	Width Breedte [mm] ←→											
			2200	2300	2400	2500	2600	2700	2800	2900	3000	3100	3200	
150	850	1000	6	6	6	6	6	6	6	6	6	6	6	6
	950	1100	6	6	6	6	6	6	6	6	6	6	6	6
	1050	1200	6	6	6	6	6	6	8	8	8	8	8	
	1150	1300	6	6	6	6	8	8	8	8	8	10	10	
165	1235	1400	6	6	8	8	8	8	10	10	10	10	10	
	1335	1500	6	8	8	8	10	10	10	10	10	10	10	
	1435	1600	8	8	10	10	10	10	10	10	15	15	15	
180	1520	1700	8	10	10	10	10	10	15	15	15	15	15	
	1620	1800	10	10	10	10	10	15	15	15	15	15	15	
	1720	1900	10	10	10	15	15	15	15	15	15	15	15	
	1820	2000	10	15	15	15	15	15	15	15	15	15	15	
	1920	2100	15	15	15	15	15	15	15	15	15	15	15	
205	1995	2200	15	15	15	15	15	15	15	15	15	20	20	
	2095	2300	15	15	15	15	15	15	15	20	20	20	20	
	2195	2400	15	15	15	15	15	15	20	20	20	20	20	
	2295	2500	15	15	15	15	20	20	20	20	20	20	20	
	2395	2600	15	15	15	20	20	20	20	20	20	20	20	
	2495	2700	15	15	20	20	20	20	20	20	20	20	25	
	2595	2800	15	20	20	20	20	20	20	20	20	25	25	
	2695	2900	20	20	20	20	20	20	20	20	20	25	25	
	2795	3000	20	20	20	20	20	20	20	20	20	25	25	

Shortening sizes

Afkortmaten

Part Onderdeel			
	Slat Lamel	<->	- 72 mm
	Top cover Bovenkap	<->	- 6 mm
	Top cover Bovenkap - round rond	<->	- 6 mm
	Bottom cover Onderkap - 45°	<->	- 6 mm
	Bottom cover Onderkap - round rond	<->	- 6 mm
	Bottom slat Onderlijst	<->	- 72 mm
	Side guide Zijgeleider	<->	Depending of boxsize Afhankelijk van de kapmaat
	Tube Buis	<->	Depending on the operation type Afhankelijk van het soort bediening
	8k40 8k60		

Exploded view

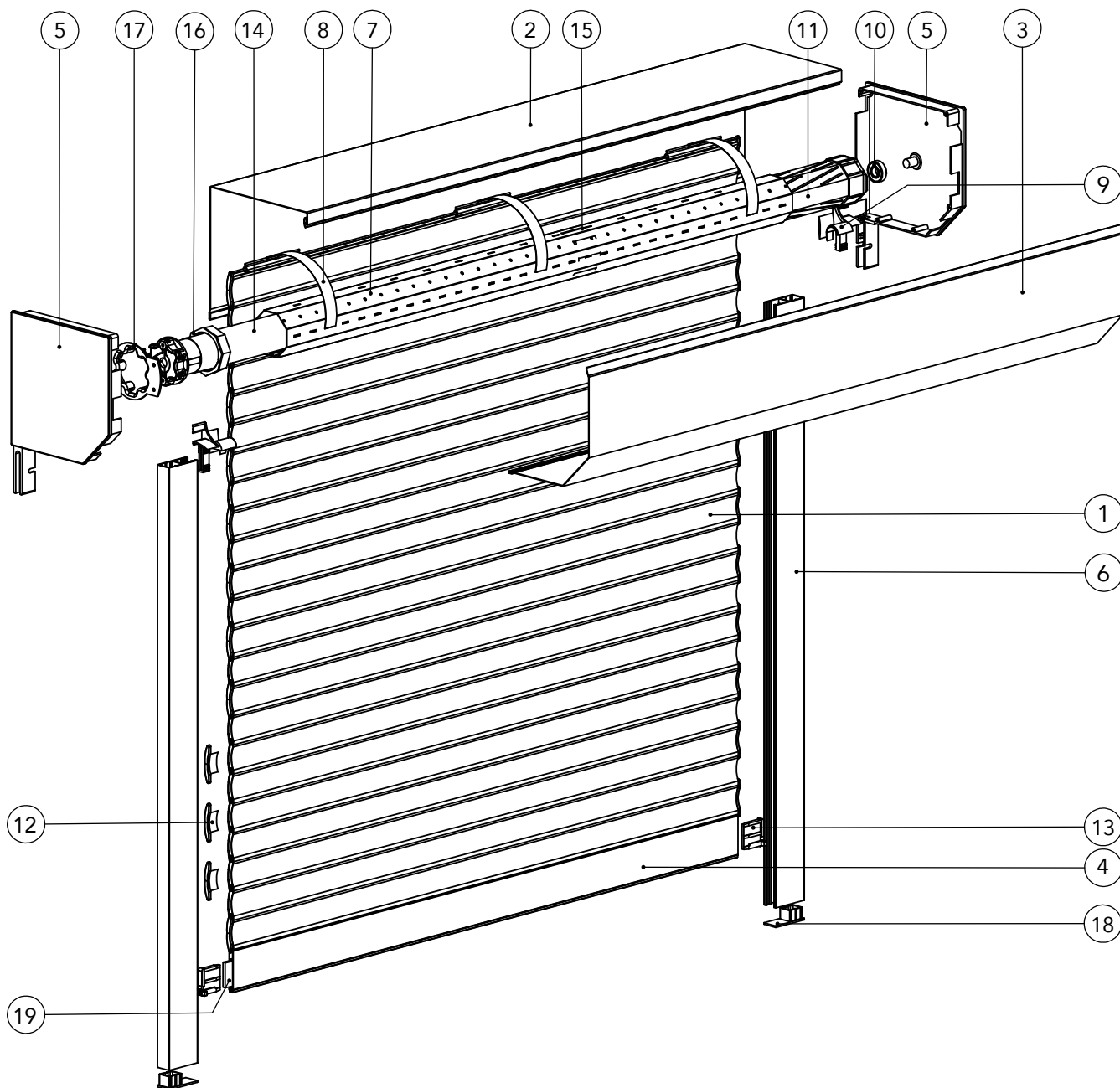

Bill of material

Stuklijst

Part Onderdeel	Description Omschrijving	Quantity Hoeveelheid
GENERAL ALGEMEEN		
1	Slats Lamellen	Depending on heigth and slat type Afhankelijk van de hoogte en lamel type
2	Top cover Bovenkap	1
3	Bottom cover Onderkap	1
4	Bottom slat Onderlijst	1
5	Side cover Zijkappen - L+R	1
6	Guide Zijgeleider	2
7	Tube Buis	1
8	Springs Ophangveren	Depending on widht Afhankelijk van de breedte
9	Run-ins Inloopstukken	2
10	Bearing Kogellager	1
11	Plug Prop	1
12	Slat guide Arreteerkap	Depending on number of slats Afhankelijk van het aantal lamellen
13	End stop bottom slat Eindstop	2
18	End cover Afsluitdop	2 -Optional
19	Weight bottom slat Verzwaring onderlijst	Optional
MOTORIZED ELEKTRISCH		
14	Motor	1
15	Drive Meenemer	1
16	Crown tube Adapter buis	1
17	Motorbracket Motorsteun	1

Parts list

Onderdelenlijst

Part Onderdeel	Part No. Art.nr	Description Omschrijving	Length in m' Unit
-------------------	--------------------	-----------------------------	----------------------

SLATS | LAMELLEN

1

**Mini E - Slat with slot | Lamel met sleuf**

ART-000754	traffic white verkeerswit
ART-000755	grey grijs
ART-000756	brown bruin
ART-000757	hell-beige
ART-000758	natural naturel
ART-000759	beige
ART-000760	teak
ART-000761	crème
ART-000762	Brons
ART-000763	red rood
ART-000764	forrest green bosgroen
ART-000765	steel blue staalblauw
ART-000766	anthracite antraciet
ART-000767	ivory ivoor
ART-035571	white wit (9010)
ART-035572	grey grijs alu
ART-035573	black zwartgrijs (7021)
ART-035574	dark alu donker alu

Mini E - Slat without slot | Lamel zonder sleuf

ART-000768	traffic white verkeerswit
ART-000769	grey grijs
ART-000770	brown bruin
ART-000771	hell-beige
ART-000772	natural naturel
ART-000773	beige
ART-000774	teak
ART-000775	crème
ART-000777	red rood
ART-000778	forrest green bosgroen
ART-000779	steel blue staalblauw
ART-000780	anthracite antraciet
ART-000781	ivory ivoor
ART-035575	white wit (9010)
ART-035576	grey grijs alu
ART-035577	black zwartgrijs (7021)
ART-035578	dark alu donker alu

Parts list

Onderdelenlijst

Part Onderdeel	Part No. Art.nr	Description Omschrijving	Length in m' Unit
-------------------	--------------------	-----------------------------	----------------------

SLATS | LAMELLEN

1

**HK842 - Slat with slot | Lamel met sleuf**

ART-000782	traffic white verkeerswit
ART-000783	grey grijs
ART-000784	brown bruin
ART-000785	hell-beige
ART-000786	natural naturel
ART-000787	beige
ART-000788	teak
ART-000789	crème
ART-000790	red rood
ART-000791	forrest green bosgroen
ART-000792	steel blue staalblauw
ART-000793	anthracite antraciet
ART-000794	ivory ivoor
ART-030758	quartz grey kwartsgrijs
ART-030759	black grey zwartgrijs
ART-030760	umbre grey ombergrijs

HK842 - Slat without slot | Lamel zonder sleuf

ART-000795	traffic white verkeerswit
ART-000796	grey grijs
ART-000797	brown bruin
ART-000798	hell-beige
ART-000799	natural naturel
ART-000800	beige
ART-000801	teak
ART-000802	crème
ART-000803	red rood
ART-000804	forrest green bosgroen
ART-000805	steel blue staalblauw
ART-000806	anthracite antraciet
ART-000807	ivory ivoor
ART-030761	quartz grey kwartsgrijs
ART-030762	black grey zwartgrijs
ART-030763	umbre grey ombergrijs

SLAT GUIDES | ARRETEERKAPPEN

12

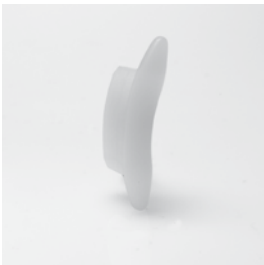
ART-000275 **Mini E - Slat guide | Arreteerkap**ART-000276 **HK842 - Slat guide | Arreteerkap**
black | zwart

Parts list

Onderdelenlijst

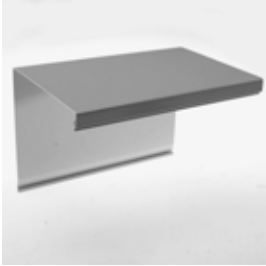
Part Onderdeel	Part No. Art.nr	Description Omschrijving	Length in m' Unit
TOP COVERS BOVENKAPPEN - FMR 45°			
2		Top cover 137 Bovenkap 137 Heroal	
		ART-000947 traffic white verkeerswit ART-000948 ivory ivoor	
		Top cover 150 Bovenkap 150 Heroal	
	ART-000949	traffic white verkeerswit	
	ART-000950	grey grijs	
	ART-000951	brown bruin	
	ART-000952	hell-beige	
	ART-000953	natural naturel	
	ART-000954	crème	
	ART-000955	red rood	
	ART-000956	forrest green bosgroen	
	ART-000957	steel blue staalblauw	
	ART-000958	anthracite antraciet	
	ART-000959	ivory ivoor	
	ART-030773	quartz grey kwartsgrijs	
	ART-030774	black grey zwartgrijs	
	ART-030775	umbre grey ombergrijs	
		Top cover 165 Bovenkap 165 Heroal	
	ART-000960	traffic white verkeerswit	
	ART-000961	grey grijs	
	ART-000962	brown bruin	
	ART-000963	hell-beige	
	ART-000964	natural naturel	
	ART-000965	crème	
	ART-000966	red rood	
	ART-000967	forrest green bosgroen	
	ART-000968	steel blue staalblauw	
	ART-000969	anthracite antraciet	
	ART-000970	ivory ivoor	
	ART-000971	anthracite textured paint antraciet structuurlak - VS716	
	ART-030776	quartz grey kwartsgrijs	
	ART-030777	black grey zwartgrijs	
	ART-030778	umbre grey ombergrijs	
		Top cover 180 Bovenkap 180 Heroal	
	ART-000972	traffic white verkeerswit	
	ART-000973	grey grijs	
	ART-000974	brown bruin	
	ART-000975	hell-beige	
	ART-000976	natural naturel	
	ART-000977	crème	
	ART-000978	red rood	
	ART-000979	forrest green bosgroen	
	ART-000980	steel blue staalblauw	
	ART-000981	anthracite antraciet	
	ART-000982	ivory ivoor	
	ART-000983	anthracite textured paint antraciet structuurlak - VS716	
	ART-030779	quartz grey kwartsgrijs	
	ART-030780	black grey zwartgrijs	
	ART-030781	umbre grey ombergrijs	

Parts list

Onderdelenlijst

Part Onderdeel	Part No. Art.nr	Description Omschrijving	Length in m' Unit
-------------------	--------------------	-----------------------------	----------------------

TOP COVERS | BOVENKAPPEN - FMR 45°

2

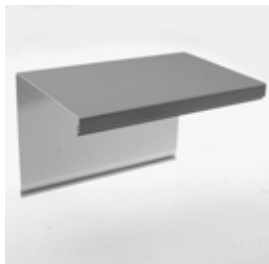
**Top cover 205 | Bovenkap 205 Heroal**

ART-000984	traffic white verkeerswit
ART-000985	grey grijs
ART-000986	brown bruin
ART-000987	hell-beige
ART-000988	natural naturel
ART-000989	crème
ART-000990	red rood
ART-000991	forrest green bosgroen
ART-000992	steel blue staalblauw
ART-000993	anthracite antraciet
ART-000994	ivory ivoor
ART-000995	anthracite textured paint antraciet structuurlak - VS716
ART-030782	quartz grey kwartsgrijs
ART-030783	black grey zwartgrijs
ART-030784	umbre grey ombergrijs

Top cover 230 | Bovenkap 230 Heroal

ART-000996	traffic white verkeerswit
ART-000997	grey grijs
ART-000998	brown bruin
ART-000999	hell-beige
ART-001000	natural naturel
ART-001001	forrest green bosgroen
ART-001002	steel blue staalblauw
ART-001003	ivory ivoor

Parts list

Onderdelenlijst

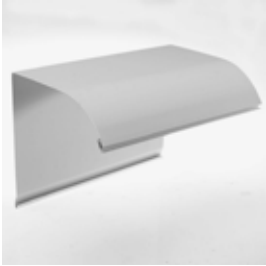
Part Onderdeel	Part No. Art.nr	Description Omschrijving	Length in m' Unit
TOP COVERS BOVENKAPPEN - FMR HC (ROUND ROND)			
2 	Top cover 150 round Bovenkap 150 rond		
	ART-001070	grey grijs	
	ART-001071	brown bruin	
	ART-001072	hell-beige	
	ART-001073	natural naturel	
	ART-001074	forrest green bosgroen	
	ART-001075	anthracite antraciet	
	ART-001076	ivory ivoor	
ART-001077	traffic white verkeerswit		
Top cover 165 round Bovenkap 165 rond			
ART-001079	grey grijs		
ART-001080	brown bruin		
ART-001081	hell-beige		
ART-001082	natural naturel		
ART-001083	forrest green bosgroen		
ART-001084	anthracite antraciet		
ART-001085	ivory ivoor		
ART-001086	traffic white verkeerswit		
Top cover 180 round Bovenkap 180 rond			
ART-001088	grey grijs		
ART-001089	brown bruin		
ART-001090	hell-beige		
ART-001091	natural naturel		
ART-001092	forrest green bosgroen		
ART-001093	anthracite antraciet		
ART-001094	ivory ivoor		
ART-001095	traffic white verkeerswit		
Top cover 205 round Bovenkap 205 rond			
ART-001097	grey grijs		
ART-001098	brown bruin		
ART-001099	hell-beige		
ART-001100	natural naturel		
ART-001101	forrest green bosgroen		
ART-001102	anthracite antraciet		
ART-001103	ivory ivoor		
ART-001104	traffic white verkeerswit		

Parts list

Onderdelenlijst

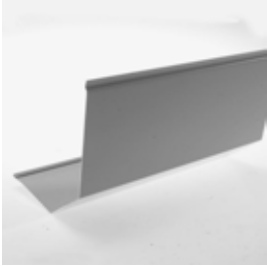
Part Onderdeel	Part No. Art.nr	Description Omschrijving	Length in m' Unit
BOTTOM COVERS ONDERKAPPEN - FMR 45°			
3		Bottom cover 137-S Onderkap 137-S Heroal	
		ART-001004	traffic white verkeerswit
		ART-001005	ivory ivoor
		Bottom cover 150-S Onderkap 150-S Heroal	
	ART-001006	traffic white verkeerswit	
	ART-001007	grey grijs	
	ART-001008	brown bruin	
	ART-001009	hell-beige	
	ART-001010	natural naturel	
	ART-001011	crème	
	ART-001012	red rood	
	ART-001013	forrest green bosgroen	
	ART-001014	steel blue staalblauw	
	ART-001015	anthracite antraciet	
	ART-001016	ivory ivoor	
	ART-030785	quartz grey kwartsgrijs	
	ART-030786	black grey zwartgrijs	
	ART-030787	umbre grey ombergrijs	
		Bottom cover 165-S Onderkap 165-S Heroal	
	ART-001017	traffic white verkeerswit	
	ART-001018	grey grijs	
	ART-001019	brown bruin	
	ART-001020	hell-beige	
	ART-001021	natural naturel	
	ART-001022	crème	
	ART-001023	red rood	
	ART-001024	forrest green bosgroen	
	ART-001025	steel blue staalblauw	
	ART-001026	anthracite antraciet	
	ART-001027	ivory ivoor	
	ART-030788	quartz grey kwartsgrijs	
	ART-030789	black grey zwartgrijs	
	ART-030790	umbre grey ombergrijs	
		Bottom cover 180-S Onderkap 180-S Heroal	
	ART-001029	traffic white verkeerswit	
	ART-001030	grey grijs	
	ART-001031	brown bruin	
	ART-001032	hell-beige	
	ART-001033	natural naturel	
	ART-001034	crème	
	ART-001035	red rood	
	ART-001036	forrest green bosgroen	
	ART-001037	steel blue staalblauw	
	ART-001038	anthracite antraciet	
	ART-001039	ivory ivoor	
	ART-001040	anthracite textured paint antraciet structuurlak - VS716	
	ART-030791	quartz grey kwartsgrijs	
	ART-030792	black grey zwartgrijs	
	ART-030793	umbre grey ombergrijs	

Parts list

Onderdelenlijst

Part Onderdeel	Part No. Art.nr	Description Omschrijving	Length in m' Unit
-------------------	--------------------	-----------------------------	----------------------

BOTTOM COVERS | ONDERKAPPEN - FMR 45°

3

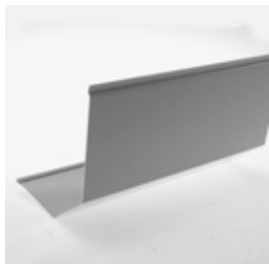
**Bottom cover 205-S | Onderkap 205-S Heroal**

ART-001041	traffic white verkeerswit
ART-001042	grey grijs
ART-001043	brown bruin
ART-001044	hell-beige
ART-001045	natural naturel
ART-001046	crème
ART-001047	red rood
ART-001048	forrest green bosgroen
ART-001049	steel blue staalblauw
ART-001050	anthracite antraciet
ART-001051	ivory ivoor
ART-001052	anthracite textured paint antraciet structuurlak - VS716
ART-030794	quartz grey kwartsgrijs
ART-030795	black grey zwartgrijs
ART-030796	umbre grey ombergrijs

Bottom cover 230-S | Onderkap 230-S Heroal

ART-001053	traffic white verkeerswit
ART-001054	grey grijs
ART-001055	brown bruin
ART-001056	hell-beige
ART-001057	natural naturel
ART-001058	forrest green bosgroen
ART-001059	anthracite antraciet
ART-001060	ivory ivoor

Parts list

Onderdelenlijst

Part Onderdeel	Part No. Art.nr	Description Omschrijving	Length in m' Unit
-------------------	--------------------	-----------------------------	----------------------

BOTTOM COVERS | ONDERKAPPEN - FMR HC (ROUND | ROND)

3

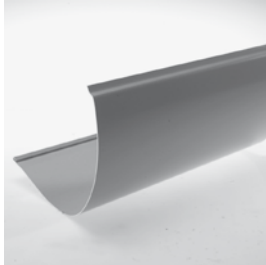
**Bottom cover 150 round | Onderkap 150 rond**

ART-001105	white wit
ART-001106	grey grijs
ART-001107	brown bruin
ART-001108	hell-beige
ART-001109	natural naturel
ART-001110	forrest green bosgroen
ART-001111	anthracite antraciet
ART-001112	ivory ivoor
ART-001113	traffic white verkeerswit

Bottom cover 165 round | Onderkap 165 rond

ART-001114	white wit
ART-001115	grey grijs
ART-001116	brown bruin
ART-001117	hell-beige
ART-001118	natural naturel
ART-001119	forrest green bosgroen
ART-001120	anthracite antraciet
ART-001121	ivory ivoor
ART-001122	traffic white verkeerswit

Bottom cover 180 round | Onderkap 180 rond

ART-001123	white wit
ART-001124	grey grijs
ART-001125	brown bruin
ART-001126	hell-beige
ART-001127	natural naturel
ART-001128	forrest green bosgroen
ART-001129	anthracite antraciet
ART-001130	ivory ivoor
ART-001131	traffic white verkeerswit

Bottom cover 205 round | Onderkap 205 rond

ART-001132	white wit
ART-001133	grey grijs
ART-001134	brown bruin
ART-001135	hell-beige
ART-001136	natural naturel
ART-001137	forrest green bosgroen
ART-001138	anthracite antraciet
ART-001139	ivory ivoor
ART-001140	traffic white verkeerswit

Parts list

Onderdelenlijst

Part Onderdeel	Part No. Art.nr	Description Omschrijving	Length in m' Unit
-------------------	--------------------	-----------------------------	----------------------

BOTTOM SLATS | ONDERLIJSTEN

4

**Bottom slat with rubber | Onderlijst met rubber - Heroal
60x7,5 mm**

ART-000820	mill finish onbewerkt
ART-000821	traffic white verkeerswit
ART-000822	grey grijs
ART-000823	brown bruin
ART-000824	hell-beige
ART-000825	naturel
ART-000826	crème
ART-000827	red rood
ART-000828	forrest green bosgroen
ART-000829	steel blue staalblauw
ART-000830	anthracite antraciet
ART-000831	ivory ivoor
ART-000832	anthracite textured paint antraciet structuurlak - VS716
ART-030764	quartz grey kwartsgrijs
ART-030765	black grey zwartgrijs
ART-030766	umbre grey ombergrijs

Parts list

Onderdelenlijst

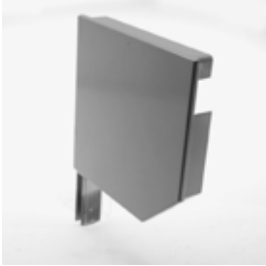
Part Onderdeel	Part No. Art.nr	Description Omschrijving	Length in m' Unit	
SIDE COVERS ZIJKAPPEN - FMR 45°				
5		Side cover 137 Zijkap 137 Heroal - L+R		
		ART-000112 traffic white verkeerswit		
	ART-000113 ivory ivoor			
	<hr/>			
		Side cover 150 Zijkap 150 Heroal - L+R		
	ART-000178 mill finish onbewerkt			
	ART-000115 traffic white verkeerswit			
	ART-000116 grey grijs			
	ART-000117 brown bruin			
	ART-000118 hell-beige			
	ART-000119 natural naturel			
	ART-000120 crème			
	ART-000121 red rood			
	ART-000122 forrest green bosgroen			
	ART-000123 steel blue staalblauw			
ART-000124 anthracite antraciet				
ART-000125 ivory ivoor				
ART-030747 quartz grey kwartsgrijs				
ART-032119 black grey zwartgrijs				
ART-030748 umbre grey ombergrijs				
<hr/>				
	Side cover 165 Zijkap 165 Heroal - L+R			
ART-000179 mill finish onbewerkt				
ART-000128 traffic white verkeerswit				
ART-000129 grey grijs				
ART-000130 brown bruin				
ART-000131 hell-beige				
ART-000132 natural naturel				
ART-000133 crème				
ART-000134 red rood				
ART-000135 forrest green bosgroen				
ART-000136 steel blue staalblauw				
ART-000137 anthracite antraciet				
ART-000138 ivory ivoor				
ART-000140 anthracite textured paint antraciet structuurlak - VS716				
ART-030749 quartz grey kwartsgrijs				
ART-030750 black grey zwartgrijs				
ART-030751 umbre grey ombergrijs				

Parts list

Onderdelenlijst

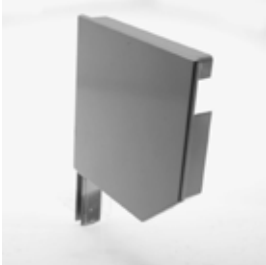
Part Onderdeel	Part No. Art.nr	Description Omschrijving	Length in m' Unit
SIDE COVERS ZIJKAPPEN - FMR 45°			
5		Side cover 180 Zijkap 180 Heroal - L+R	
		ART-000180	mill finish onbewerkt
		ART-000142	traffic white verkeerswit
		ART-000143	grey grijs
		ART-000144	brown bruin
		ART-000145	hell-beige
		ART-000146	natural naturel
		ART-000147	crème
		ART-000148	red rood
		ART-000149	forrest green bosgroen
		ART-000150	steel blue staalblauw
		ART-000151	anthracite antraciet
		ART-000152	ivory ivoor
		ART-000154	anthracite textured paint antraciet structuurlak - VS716
		ART-030752	quartz grey kwartsgrijs
ART-030753	black grey zwartgrijs		
ART-030754	umbre grey ombergrijs		
<hr/>			
		Side cover 205 Zijkap 205 Heroal - L+R	
	ART-000181	mill finish onbewerkt	
	ART-000156	traffic white verkeerswit	
	ART-000157	grey grijs	
	ART-000158	brown bruin	
	ART-000159	hell-beige	
	ART-000160	natural naturel	
	ART-000161	crème	
	ART-000162	red rood	
	ART-000163	forrest green bosgroen	
	ART-000164	steel blue staalblauw	
	ART-000165	anthracite antraciet	
	ART-000166	ivory ivoor	
	ART-000168	anthracite textured paint antraciet structuurlak - VS716	
	ART-030755	quartz grey kwartsgrijs	
	ART-030756	black grey zwartgrijs	
	ART-030757	umbre grey ombergrijs	
<hr/>			
		Side cover 230 Zijkap 230 Heroal - L+R	
	ART-000170	traffic white verkeerswit	
	ART-000171	grey grijs	
	ART-000172	brown bruin	
	ART-000173	hell-beige	
	ART-000174	natural naturel	
	ART-000175	forrest green bosgroen	
	ART-000176	steel blue staalblauw	
	ART-000177	ivory ivoor	

Parts list

Onderdelenlijst

Part Onderdeel	Part No. Art.nr	Description Omschrijving	Length in m' Unit
-------------------	--------------------	-----------------------------	----------------------

SIDE COVERS | ZIJKAPPEN - BLK HC (ROUND | ROND)

5



Side cover 150 round Zijkap rond 150 - L+R	
ART-000186	mill finish onbewerkt
ART-000188	grey grijs
ART-000189	brown bruin
ART-000190	hell-beige
ART-000191	natural naturel
ART-000192	forrest green bosgroen
ART-000193	anthracite antraciet
ART-000194	ivory ivoor
ART-000195	traffic white verkeerswit

Side cover 165 round Zijkap 165 rond - L+R	
ART-000196	mill finish onbewerkt
ART-000198	grey grijs
ART-000199	brown bruin
ART-000200	hell-beige
ART-000201	natural naturel
ART-000202	forrest green bosgroen
ART-000203	anthracite antraciet
ART-000204	ivory ivoor
ART-000205	traffic white verkeerswit

Side cover 180 round Zijkap 180 rond - L+R	
ART-000206	mill finish onbewerkt
ART-000208	grey grijs
ART-000209	brown bruin
ART-000210	hell-beige
ART-000211	natural naturel
ART-000212	forrest green bosgroen
ART-000213	anthracite antraciet
ART-000214	ivory ivoor
ART-000215	traffic white verkeerswit

Side cover 205 round Zijkap 205 rond - L+R	
ART-000216	mill finish onbewerkt
ART-000218	grey grijs
ART-000219	brown bruin
ART-000220	hell-beige
ART-000221	natural naturel
ART-000222	forrest green bosgroen
ART-000223	anthracite antraciet
ART-000224	ivory ivoor
ART-000225	traffic white verkeerswit

Parts list

Onderdelenlijst

Part Onderdeel	Part No. Art.nr	Description Omschrijving	Length in m' Unit
-------------------	--------------------	-----------------------------	----------------------

COVER PLATES | AFDEKPLATEN - ROUND | ROND

ART-000182 **Coverplate 150 round, hole 72 |
Afdekplaat 150 rond, gat 72**

ART-000183 **Coverplate 165 round, hole 72 |
Afdekplaat 165 rond, gat 72**

ART-000184 **Coverplate 180 round, hole 72 |
Afdekplaat 180 rond, gat 72**

ART-000185 **Coverplate 205 round, hole 72 |
Afdekplaat 205 rond, gat 72**

CENTRE COVER SUPPORTS | MIDDENKAPSTEUNEN



ART-000126 **Centre cover support | Middenkapsteun 150**
buffed edge | afgeslepen rand Heroal



ART-000139 **Centre cover support | Middenkapsteun 165**
buffed edge | afgeslepen rand Heroal

ART-000153 **Centre cover support | Middenkapsteun 180**
buffed edge | afgeslepen rand Heroal

ART-000167 **Centre cover support | Middenkapsteun 205**
buffed edge | afgeslepen rand Heroal

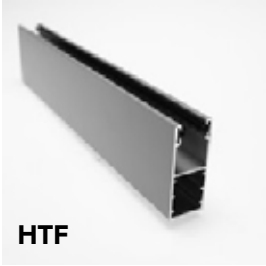
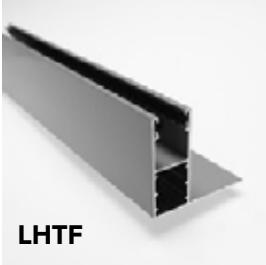

Parts list

Onderdelenlijst

Part Onderdeel	Part No. Art.nr	Description Omschrijving	Length in m' Unit
GUIDES ZIJGELEIDERS			
6  HTF	ART-000834	traffic white verkeerswit	
	ART-000835	grey grijs	
	ART-000836	brown bruin	
	ART-000837	hell-beige	
	ART-000838	natural naturel	
	ART-000839	crème	
	ART-000840	red rood	
	ART-000841	forrest green bosgroen	
	ART-000842	steel blue staalblauw	
	ART-000843	anthracite antraciet	
	ART-000844	ivory ivoor	
	ART-000845	anthracite textured paint antraciet structuurlak - VS716	
	ART-030767	quartz grey kwartsgrijs	
	ART-030768	black grey zwartgrijs	
ART-030769	umbre grey ombergrijs		
 LHTF	ART-000848	traffic white verkeerswit	
	ART-000849	grey grijs	
	ART-000850	brown bruin	
	ART-000851	hell-beige	
	ART-000852	natural naturel	
	ART-000853	crème	
	ART-000854	red rood	
	ART-000855	forrest green bosgroen	
	ART-000856	steel blue staalblauw	
	ART-000857	anthracite antraciet	
	ART-000858	ivory ivoor	
	ART-000859	anthracite textured paint antraciet structuurlak - VS716	
	ART-030770	quartz grey kwartsgrijs	
	ART-030771	black grey zwartgrijs	
ART-030772	umbre grey ombergrijs		
 HF	ART-000862	traffic white verkeerswit	
	ART-000863	grey grijs	
	ART-000864	brown bruin	
	ART-000865	hell-beige	
	ART-000866	natural naturel	
	ART-000867	crème	
	ART-000868	red rood	
	ART-000869	forrest green bosgroen	
	ART-000870	steel blue staalblauw	
	ART-000871	anthracite antraciet	
	ART-000872	ivory ivoor	
	ART-000873	anthracite textured paint antraciet structuurlak - VS716	

Parts list

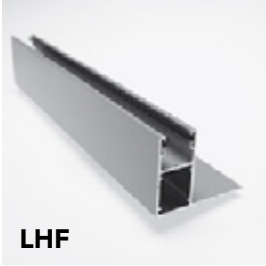
Onderdelenlijst

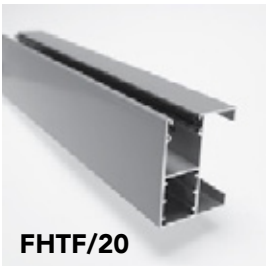
Part Onderdeel	Part No. Art.nr	Description Omschrijving	Length in m' Unit
GUIDES ZIJGELEIDERS			
6  MHTF	ART-000930	traffic white verkeerswit	
	ART-000931	grey grijs	
	ART-000932	brown bruin	
	ART-000933	hell-beige	
	ART-000934	natural naturel	
	ART-000935	crème	
	ART-000936	forrest green bosgroen	
	ART-000937	steel blue staalblauw	
	ART-000938	anthracite antraciet	
	ART-000939	ivory ivoor	
 LHF	ART-000875	traffic white verkeerswit	
	ART-000876	grey grijs	
	ART-000877	brown bruin	
	ART-000878	hell-beige	
	ART-000879	natural naturel	
	ART-000880	crème	
	ART-000881	red rood	
	ART-000882	forrest green bosgroen	
	ART-000883	steel blue staalblauw	
	ART-000884	anthracite antraciet	
ART-000885	ivory ivoor		
ART-000886	anthracite textured paint antraciet structuurlak - VS716		
 FHTF/12	ART-000888	traffic white verkeerswit	
	ART-000889	grey grijs	
	ART-000890	brown bruin	
	ART-000891	hell-beige	
	ART-000892	natural naturel	
	ART-000893	crème	
	ART-000894	red rood	
	ART-000895	forrest green bosgroen	
	ART-000896	steel blue staalblauw	
	ART-000897	anthracite antraciet	
ART-000898	ivory ivoor		
 FHTF/20	ART-000900	traffic white verkeerswit	
	ART-000901	grey grijs	
	ART-000902	brown bruin	
	ART-000903	hell-beige	
	ART-000904	natural naturel	
	ART-000905	crème	
	ART-000906	red rood	
	ART-000907	forrest green bosgroen	
	ART-000908	steel blue staalblauw	
	ART-000909	anthracite antraciet	
ART-000910	ivory ivoor		

Parts list

Onderdelenlijst

Part Onderdeel	Part No. Art.nr	Description Omschrijving	Length in m' Unit
-------------------	--------------------	-----------------------------	----------------------

GUIDES | ZIJGELEIDERS

6	BLHTF/120	ART-000917 ART-000919 ART-000920 ART-000921	Guide Zijgeleider BLHTF Heroal brown bruin natural naturel anthracite antraciet ivory ivoor
---	-----------	--	--

HTF/67	ART-000923 ART-000924 ART-000925 ART-000926 ART-000927	Guide Zijgeleider - HTF/67 Heroal traffic white verkeerswit grey grijs brown bruin forrest green bosgroen ivory ivoor
--------	--	---

CORNER PROFILES | HOEKPROFIELEN

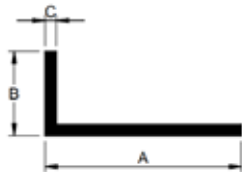





	Corner profile Hoekprofiel - 30x20x2
ART-000397	traffic white verkeerswit
ART-000398	grey grijs
ART-000399	brown bruin
ART-000400	hell-beige
ART-000401	natural naturel
ART-000402	crème
ART-000403	red rood
ART-000404	black zwart
ART-000405	forrest green bosgroen
ART-000406	blue blauw (5011)
ART-000407	anthracite grey antracietgrijs (7016)
ART-000408	ivory ivoor
ART-000409	anthracite textured paint antraciet structuurlak - VS716

	Corner profile Hoekprofiel - 70x20x2
ART-000410	traffic white verkeerswit
ART-000411	grey grijs
ART-000412	brown bruin
ART-000413	hell-beige
ART-000414	natural naturel
ART-000415	crème
ART-000416	red rood
ART-000417	black zwart
ART-000418	forrest green bosgroen
ART-000419	blue blauw (5011)
ART-000420	anthracite grey antracietgrijs (7016)
ART-000421	ivory ivoor
ART-000422	anthracite textured paint antraciet structuurlak - VS716

	Corner profile Hoekprofiel - 70x30x2
ART-000423	white wit (9010)
ART-000424	ivory ivoor
ART-000425	white wit
ART-000426	grey grijs
ART-000427	brown bruin
ART-000428	hell-beige
ART-000429	forrest green bosgroen
ART-000430	ivory ivoor (9001)





Parts list

Onderdelenlijst

Part Onderdeel	Part No. Art.nr	Description Omschrijving	Length in m' Unit
TUBES AND ACCESSORIES STALEN BUIZEN EN TOEBEHOREN			
7		ART-001209 Steel tube Stalen buis 8K40 X 0,8 mm	6,0 m ¹
		ART-001210 Steel tube Stalen buis 8K60 x 0,9 mm	6,0 m ¹
19		Weight bottom slat Verzwarengstrip onderlijst	
		ART-000366 galvanised verzinkt - 25x3 mm 2,5 m	500 mm
		ART-000367	750 mm
		ART-000368	1000 mm
		ART-000292 Filler ring 8K60 Ø80 Opvulring 8K60 naar Ø80	
SPRINGS OPHANGVEREN			
8		ART-000298 Spring Ophangveer - 13 cm	
		ART-000300 Spring Ophangveer - 17 cm	
		ART-000302 Spring Ophangveer - 19 cm	
ACCESSORIES ROUND ACCESSOIRES ROND			
		Coverprofile round Afdekprofiel rond	
	ART-001061	white wit (9010)	
	ART-001062	brown bruin	
	ART-001063	hell-beige	
	ART-001064	natural naturel	
	ART-001065	forrest green bosgroen	
	ART-001066	anthracite antraciet	
	ART-001067	ivory ivoor	
	ART-001068	traffic white verkeerswit	
18		End cover Afsluitdop rond Heroal	
		ART-000107	white wit
		ART-000108	brown bruin
		ART-000109	hell-beige
		ART-000110	black zwart
		ART-000111	forrest green bosgroen



Parts list

Onderdelenlijst

Part Onderdeel	Part No. Art.nr	Description Omschrijving	Length in m' Unit
CAPS AND STOPS DOPPEN EN STOPPEN			
13		ART-000259	End stop bottom slat - Fixed Eindstop onderlijst - Vast
		ART-000260	End stop bottom slat - Rotatable Eindstop onderlijst - Draaibaar
	Cover caps Bol Afdekopje 10 mm - 8 stuks		
	ART-000241	white wit	
	ART-000242	grey grijs	
	ART-000243	brown bruin	
	ART-000244	hell-beige	
	ART-000245	natural naturel	
	ART-000246	cream crème	
	ART-000247	red rood	
	ART-000248	black zwart	
	ART-000249	dark green donkergroen	
	ART-000250	steel blue staalblauw	
	ART-000251	anthracite antracietgrijs	
	ART-000252	ivory ivoor (9001)	
	ART-032191	quartz grey kwartsgrijs	
ART-032192	black grey zwartgrijs		
ART-032193	umbre grey ombergrijs		
	Stop flat plastic Aanslagstop plat kunststof - 40 mm		
	ART-000253	white wit	
	ART-000254	grey grijs	
	ART-000255	brown bruin	
	ART-000256	hell-beige	
	ART-000257	anthracite antraciet	
	ART-000258	ivory ivoor	
RUN-INS INLOOPSTUKKEN			
9		Run-in Inloopstuk HTF/LHTF/MHTF	
		ART-000309	white wit
	ART-031406	black zwart	
		Run-in Inloopstuk HF/LHF	
		ART-000310	white wit
	ART-031407	black zwart	
	ART-000363	Run-in small Inloopstuk smal - 45 mm	brown bruin





Parts list

Onderdelenlijst

Part Onderdeel	Part No. Art.nr	Description Omschrijving	Length in m' Unit
PLUGS AND DISCS ASPROPPEN EN SCHIJVEN			
	ART-000283	Plug with spring 8K40/60 for bearing 28 incl. clip Prop verend 8K40/60 voor lager 28 incl. clip	
	ART-000281	Adjustable plug 8K40 for bearing 28 mm Verstelbare prop 8K40 voor lager 28 mm	
	ART-000287	Strap disc 125 Tube Bandschijf 125 Buis 8K40 & 8K60	
	ART-028233	Strap disc 135 Tube Bandschijf 135 Buis 8K40 & 8K60	
	ART-000289	Strap disc 155 Tube Bandschijf 155 Buis 8K40 & 8K60	
	ART-000290	Strap disc 175 Tube Bandschijf 170 Buis 8K40 & 8K60	
	ART-000291	Strap disc 190 Tube Bandschijf 190 mm 8K40/50/60	
	ART-000295	Mounting plate with axle Bevestigingsplaat met as 12 mm	



Parts list

Onderdelenlijst

Part Onderdeel	Part No. Art.nr	Description Omschrijving	Length in m' Unit
DECELERATORS / REDUCTION VERTRAGERS / REDUCTIE			
	ART-000316	Strap disc with decelerator Bandschijf met vertrager 140 mm 1:3 Tensile strength 35 kg - box 165 Trekkkracht 35 kg - kast 165	
	ART-000317	Strap disc with decelerator Bandschijf met vertrager 160 mm 1:3 Tensile strength 35 kg - box 180 Trekkkracht 35 kg - kast 180	
	ART-000318	Strap disc with decelerator Bandschijf met vertrager 180 mm 1:3 Tensile strength 35 kg - box 205 Trekkkracht 35 kg - kast 205	
	ART-000311	Axle plug 8K40 aluminium for decelerator Asprop 8K40 aluminium t.b.v. vertrager	
	ART-000312	Axle plug 8K60 aluminium for decelerator Asprop 8K60 aluminium t.b.v. vertrager	
BEARINGS AND BEARING HOLDERS LAGERS EN LAGERHOUDERS			
10		ART-033324 Bearing Groefkogellager 28 mm	
LINK AND EXTEND KOPPELEN EN VERLENGEN			
	ART-000306	Coupling for pipe 8K60 with bearing block Koppelstuk voor buis 8K60 met lagerblok	
	ART-000305	Coupling 8K60 adjustable to different heights Koppelstuk 8K60 met verschillende hoogte instelbaar	



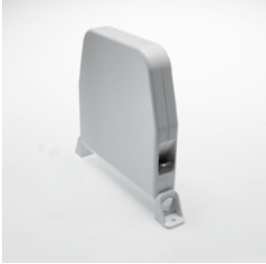
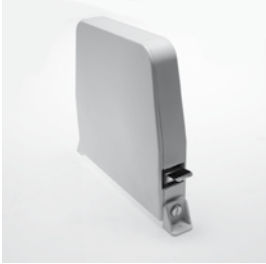

Parts list

Onderdelenlijst

Part Onderdeel	Part No. Art.nr	Description Omschrijving	Length in m' Unit
STRAP WINDERS BANDOPWINDERS			
	ART-000319	Strap winder hinged Bandopwinder scharnierend (4.5 m strap band)	
	ART-000320	white wit brown bruin	
	ART-000321	Strap winder Bandopwinder (11 m strap band)	
	ART-000322	white wit brown bruin	
WINDING MECHANISM STRAP BANDWINDWERKEN			
	ART-000323	Winding mechanism strap Bandwindwerk - 1:3	
	ART-000324	white wit brown bruin	
	ART-000351	Crank for winding mechanism strap Slinger voor bandwindwerk	
	ART-000352	13 cm 16 cm	
	ART-000325	Bevestigingshoek voor vertraging Mounting piece for decelerator	
		white wit	

Parts list

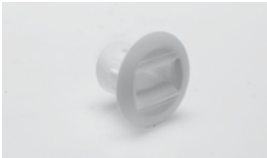
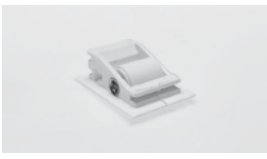
Onderdelenlijst

Part Onderdeel	Part No. Art.nr	Description Omschrijving	Length in m' Unit
STRAP GUIDES BANDGELEIDERS			
	ART-000333	Strap guide (14 mm) steel with nylon rollers Bandgeleider (14 mm) staal met kunststof rollen galvanised verzinkt	
	ART-000334	Strap guide (14 mm) steel with nylon roller, brush and cover Bandgeleider (14 mm) staal met kunststof rol, borstel en afdekkap white wit	
	ART-000335	Strap guide (14 mm) plastic insert with nylon roller Bandgeleider (14 mm) kunststof insteek met nylon rol white wit	
	ART-000337	Strap guide (14 mm) plastic insert Bandgeleider (14 mm) kunststof inslag white wit	
	ART-000338 ART-000339	Strap guide (14 mm) plastic for side cover Bandgeleider (14 mm) kunststof voor zijkap white wit brown bruin	
	ART-000341	Cover for strap guide plastic round Afdekplaatje voor bandgeleiders PVC rond white wit	

Parts list

Onderdelenlijst

Part Onderdeel	Part No. Art.nr	Description Omschrijving	Length in m' Unit
PULL-UP STRAP AND CORD OPTREKBAND EN KOORD			
	ART-000332	Strap Band 14 mm black-white zwart-wit black-white zwart-wit	1000 m
	ART-000330 ART-000331	Strap Band 14 mm grey grijs brown bruin	50 m
	ART-000347	Cord Koord - nylon 4.2 mm black-white zwart-wit	100 m
CORD WINDERS KOORDOPWINDERS			
	ART-000343	Cord winder Koordopwinder - 4.5 mtr white wit	
	ART-035180	older type, can only be ordered separately. ouder type, alleen als los artikel te bestellen.	
	ART-000344	Cord winder Koordopwinder - 11 mtr white wit	
	ART-000345	Cord winder decelerator Koordwindwerk vertraging - 1:3 tensile strength 3 kg, with freewheel trekkracht 3 kg, met vrijloop white wit	
	ART-000351 ART-000352	Crank for cord winder Slinger voor koordwindwerk 13 cm 16 cm	



Parts list



Onderdelenlijst

Part Onderdeel	Part No. Art.nr	Description Omschrijving	Length in m' Unit
CORD GUIDE KOORDGELEIDERS			
	ART-000346	Cord guide plastic, steel roll + spring Koordgeleider PVC, stalen rol + veer 250 mm white wit	
	ART-000349	Cord guide plastic for side cover Koordgeleider PVC voor in zijkap white wit	
(OOG)WINDWERKEN			
	ART-000356	Lifting gear 1:8, inside operation, square shaft 13 mm Oogwindwerk 1:8, binnenbediening, vierkante as 13 mm black zwart	
	ART-000357	Eye with square shaft 8 mm, length 15 cm Oog met vierkante as 8 mm, lengte 15 cm	
	ART-000313	Alu Bearing set 8K40 for mono Alu Lagerprop 8K40 voor mono	
	ART-000314	Alu Bearing set 8K40 for mono Alu Lagerprop 8K60 voor mono	
SPRING ROLLERS VEERROLLEN			
	ART-000361	Spring roller for tube 8K60, length 60,5 cm, tensile strength 10 kg Veerrol voor buis 8K60, lengte 60,5 cm, trekkracht 10 kg	
	ART-000360	Bracket for spring roller Ophangbeugel t.b.v. veerrol	

Parts list

Onderdelenlijst

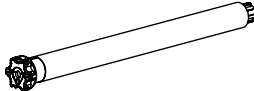
Part Onderdeel	Part No. Art.nr	Description Omschrijving	Length in m' Unit
LOCKS AND LATCHES ROLLUIKSLOTEN EN VERGREDELINGEN			
	ART-000358	Cylinder lock 9 mm with cover plate Cilinderslot 9 mm met afsluitplaat	
	ART-000359	Slide lock with button (built-in) Schuifvergrendeling met knop (inbouw)	
VARIOUS OVERIGEN			
	ART-000340	Tube PVC Doorvoerbuis PVC - 20/22 mm 3 mtr	
	ART-000944	Window sill profile Vensterbankprofiel - 70 mm ivory ivoor (9001)	
	ART-000946	Window sill profile Vensterbankprofiel - 90 mm ivory ivoor (9001)	
	ART-000106	Clamping block Klemblokje - Heroal	
	ART-000293	Mounting plate standard side cover - Heroal Montageplaat standaard zijkap - Heroal	
	ART-000364	Handle Alu. for bottom slat Handgreep Alu. voor onderlijst	
	ART-000943	PVC lining Type 3 PVC-Voering Type 3 - 10,2 mm	

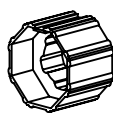
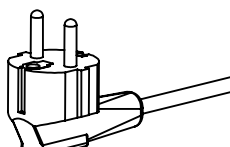
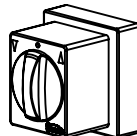
Part Onderdeel	Part No. Art.nr	Description Omschrijving	Length in m' Unit
PARTS FOR ELECTRICAL CONTROL ONDERDELEN VOOR ELEKTRISCHE BEDIENING			
		Somfy motor	
	ART-008903	Somfy adaptor buis 8K60 Lt50 Somfy adaptor tube 8K60 Lt50	
	ART-008929	Somfy motorsteun Lt50-Lt60 Somfy motor support Lt50-Lt60	
	ART-008917	Somfy meenemer, buis 8K60 Lt50 Somfy driver, tube 8K60 Lt50	
	ART-008876	Haakse stekker PVC Perpendicular power plug PVC kabel cable - 3 m	
	ART-046677	Opbouw draaischakelaar Wall-mounted rotating switch	

BOLBYR

BOLBYR

Bolbyr B.V. - Magazijnweg 27-29 - 5683 CV Best - Nederland (Netherlands)
T +31 (0)88-9876543 - sales@bolbyr.com - www.bolbyr.com