

BOLBYR®

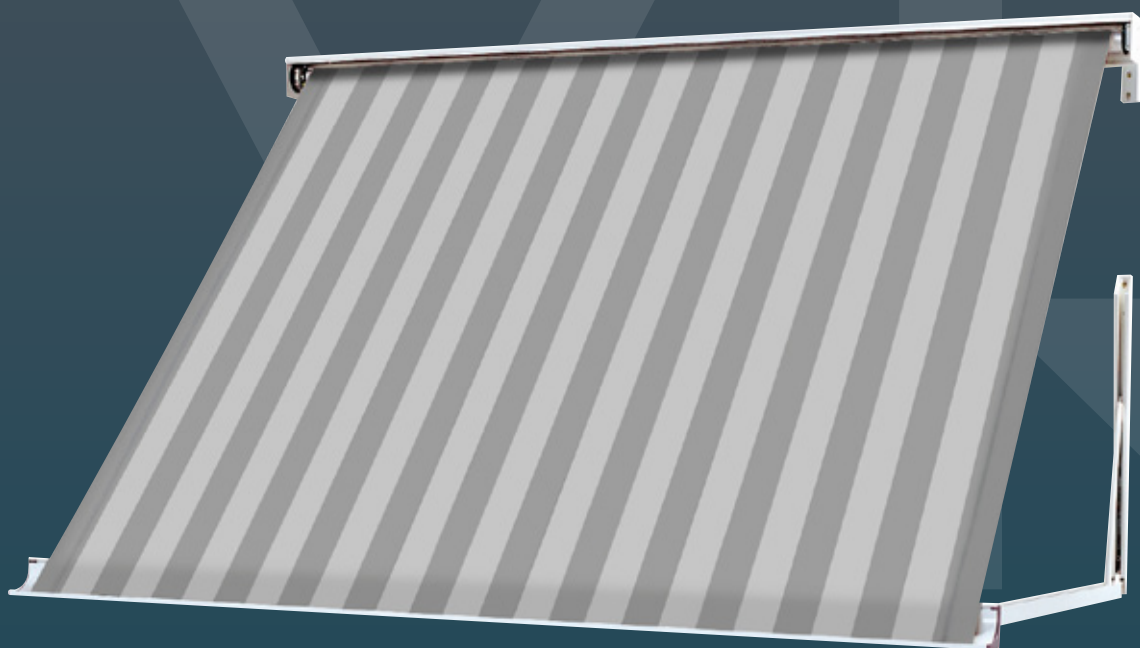

EN

NL

AWNING | ZONNESCHERM

**LEVIX**

Subject to misprints, errors and technical modifications.  
Drukfouten, fouten en technische wijzigingen voorbehouden.

23552995LEVIX-EN-NL-240322

# Contents

Inhoudsopgave

---

## **Measurements**

Maatvoering .....4

## **Technical specifications**

Technische specificaties .....5

## **Scheme Nm**

Schema Nm .....6

## **Shortening sizes**

Afkortmaten .....7

## **Exploded view**

.....8

## **Bill of material**

Stuklijst .....9

## **Parts list**

Onderdelenlijst .....10

# Measurements

Maatvoering

Cross section | Doorsnede  
 Sizes | Maten in mm

## LEVIX End fix bracket | Kapsteun

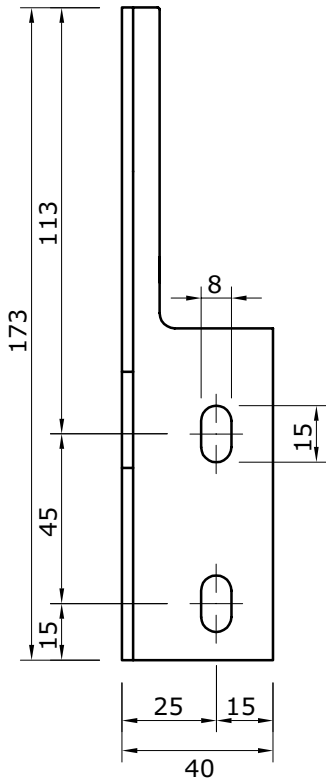

## Wall mounting | Wandmontage

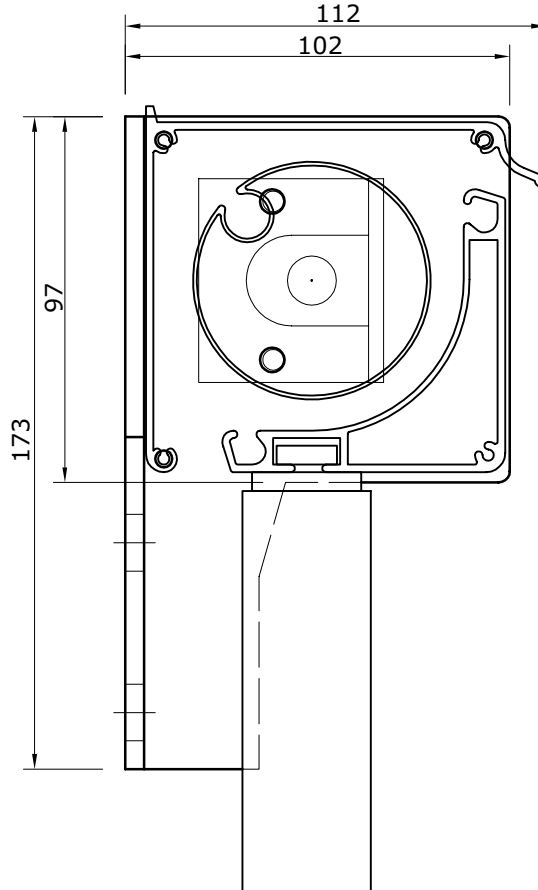

## LEVIX SPECIAL | SPECIAAL Wall bracket | Muursteun

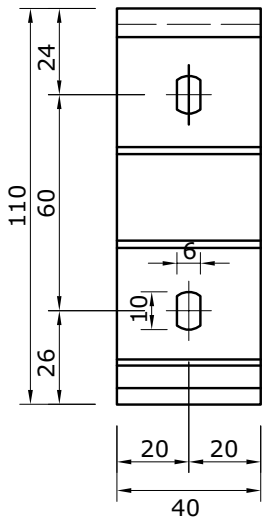



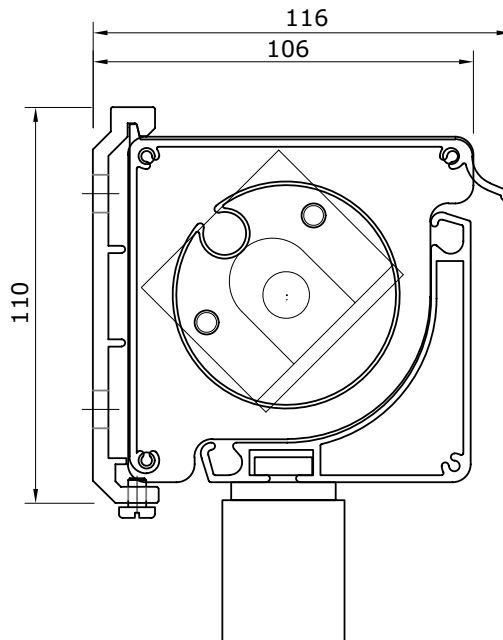

## Wall mounting | Wandmontage

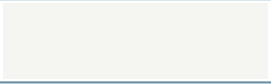

# Technical specifications



Technische specificaties

Type awning Type scherm	closed cassette gesloten cassette		
Type arms Typearmen	windproof drop-arms windvaste uitvalarmen		
Width Breedte	1000 - 8000 mm		
Projection Uitval	1000 - 1500 mm		
Available colors box Beschikbare kleuren omkasting		mill finish onbewerkt	
		white wit	
		ivory (RAL 9001) ivoor (RAL 9001)	
		anodized technisch zilver	
Minimal required Nm Minimaal benodigd Nm		10 Nm - 15 Nm - 20 Nm (see scheme   zie schema)	
Applicable fabric Toepasbaar doek	acrylic fabric acryldoek		
Maximum roll-up diameter Maximale oproldiameter	seamless uni fabric naadloos uni doek	tube Ø48 mm doekbuis Ø48 mm	max. 3000 [mm]
	strokes plain/striped banen uni/streep doek		max. 2600 [mm]
	seamless uni fabric naadloos uni doek	tube Ø63 mm doekbuis Ø63 mm	max. 2420 [mm]
	strokes plain/striped banen uni/streep doek		max. 1800 [mm]

WALL BRACKETS   MUURSTEUNEN														
Width   Breedte [mm]							Required number of wall brackets   Benodigd aantal muursteunen							
1000	1500	2000	2500	3000	3500	4000	4500	5000	5500	6000	6500	7000	7500	8000
2	2	2	3	3	4	4	5	5	6	6	7	7	8	8

# Scheme Nm

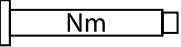
## Schema Nm

Minimal required  
Minimaal benodigd  

Projec- tion Uitval	Width   Breedte [mm]													
	1000	1250	1500	1750	2000	2250	2500	2750	3000	3250	3500	3750	4000	4250
1000	10	10	10	10	10	10	10	15	15	15	15	15	15	15
1150	10	10	10	10	10	10	10	15	15	15	15	15	15	15
1350	10	10	10	10	10	10	10	15	15	15	15	15	15	15
1500	10	10	10	10	10	10	10	15	15	15	15	15	15	15

> 3000 mm tube | buis ø63

Projec- tion Uitval	Width   Breedte [mm]														
	4500	4750	5000	5250	5500	5750	6000	6250	6500	6750	7000	7250	7500	7750	8000
1000	15	15	15	15	15	15	15	15	15	15	15	20	20	20	20
1150	15	15	15	15	15	15	15	15	15	15	15	20	20	20	20
1350	15	15	15	15	15	15	15	15	15	15	15	20	20	20	20
1500	15	15	15	15	15	15	15	15	15	15	15	20	20	20	20

> 4500 mm 3 arms + linked (fabric in parts)  
> 4500 mm 3 armen + gekoppeld (doek in delen)

# Shortening sizes

Afkortmaten

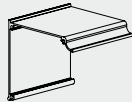
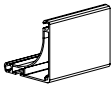
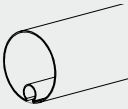
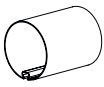
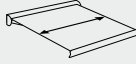
PART ONDERDEEL	CONTROL BEDIENING
 <p>Top cover   Bovenkap</p>	<p>-8 mm</p>
 <p>Front bar   Voorlijst</p>	<p>Motorized   Elektrisch</p> <p>Depending on the brand of the motor Afhankelijk van het type motor (Somfy -25 mm)</p> <hr/> <p>Gearbox   Oogwindwerk -63 mm Tapewinder   Bandopwinder -25 mm</p>
 <p>Tube ø48   Doekbuis ø48</p>	<p>Gearbox   Oogwindwerk -78 mm Tapewinder   Bandopwinder -82 mm Gearbox inside   Mono binnen -78 mm</p>
 <p>Tube ø63   Doekbuis ø63</p>	<p>Motorized   Elektrisch</p> <p>Depending on the brand of the motor Afhankelijk van het type motor (Somfy -67 mm)</p> <hr/> <p>Gearbox   Oogwindwerk -78 mm Tapewinder   Bandopwinder -82 mm Gearbox inside   Mono binnen -78 mm</p>
 <p>Fabric width   Doekbreedte (finished fabric size   afgewerkte doekmaat)</p>	<p>Motorized   Elektrisch</p> <p>Depending on the brand of the motor Afhankelijk van het type motor (Somfy -100 mm)</p> <hr/> <p>Gearbox   Oogwindwerk -110 mm Tapewinder   Bandopwinder</p>

## Exploded view

MOTORIZED | ELEKTRISCH

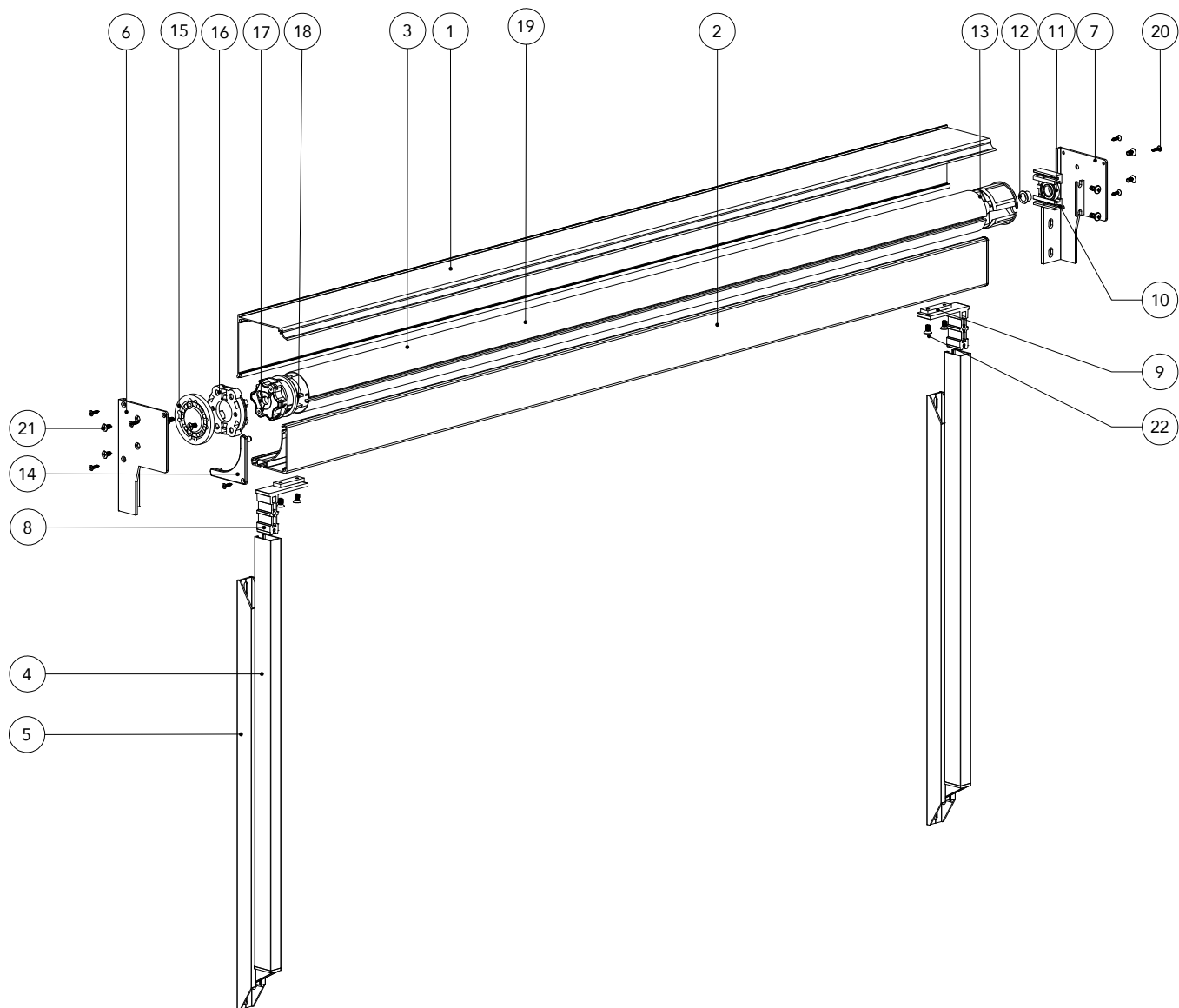





# Bill of material

## Stuklijst

MOTORIZED   ELEKTRISCH		
Item Onderdeel	Description Omschrijving	Quantity Hoeveelheid
1	Top cover   Bovenkap	1
2	Front bar   Voorlijst	1
3	Tube   Doekbuis	1
4	Drop arm projection profile   Uitvalprofiel (voorslag)	2
5	Droparm unit   Uitvalarmen unit	2
6	End fix bracket LEFT   Kapsteun LINKS	1
7	End fix bracket RIGHT   Kapsteun RECHTS	1
8	Top piece   Top stuk	1
9	Mounting kit top piece   Bevestigingspakket top stuk	2
10	Bearing block   Lagerblok	1
11	Precision bearing 32   Preciesielager 32	1
12	Nylon adapter bush from 15 to 12 mm   Aanpassingsbusje 15 naar 12 mm	1
13	Nylon bearing roller bung ø63 with spindle 12 mm   Lagerprop ø63 met as 12 mm	1
14	End cap front bar   Eindkapje voorlijst	2
15	Universal bracket   Bevestigingsschijf	1
16	Motor bracket   Motorsteun	1
17	Motor	1
18	Crown   Adapter - tube   buis ø63	1
19	Drive   Meenemer - tube   buis ø63	1
20	Self tapping screw   Zelftapper - DIN 7982 Vkkk 3.5x16 (for 2 & 14, 1 & 6, 7)	8
21	Metal screw   Metaalschroef - DIN 965 Pvk A2 M6x14 (for 6 & 10, 6 & 15)	4
22	Metal screw   Metaalschroef - DIN 965 Pvk A2 M6x10 (for 9)	4
	Motor screw   Motor schroef	2



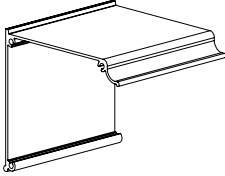
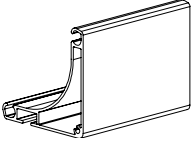
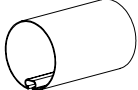
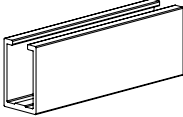
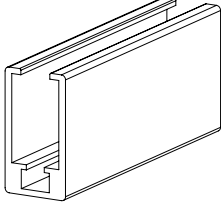

# Parts list

Onderdelenlijst

Part Onderdeel	Part No. Art.nr	Description Omschrijving	Length in m <sup>1</sup> Unit
<b>LENGTHS   LENGTES</b>			
1 	ART-006781	<b>Top cover   Bovenkap</b> mill finish   onbewerkt	7,0 m <sup>1</sup>
	ART-006782	white   wit	
	ART-006783	ivory   ivoor (RAL 9001)	
	ART-006784	anodised   technisch zilver	
2 	ART-006772	<b>Front bar   Voorlijst</b> mill finish   onbewerkt	7,0 m <sup>1</sup>
	ART-006773	white   wit	
	ART-006774	ivory   ivoor	
	ART-006775	anodised   technisch zilver	
3 	ART-032495	<b>Tube   Doekbuis - ø63 x 1,0 mm</b> galvanized   verzinkt	7,5 m <sup>1</sup>
	ART-008355	<b>Tube   Doekbuis staal - ø48 mm</b> galvanized   verzinkt - 48x0,8 mm	7,5 m <sup>1</sup>
4 	ART-006733	<b>Drop arm projection profile standard   Uitvalprofiel (voorslag) standaard</b> mill finish   onbewerkt	7,0 m <sup>1</sup>
	ART-006734	white   wit	
	ART-006735	ivory   ivoor	
	ART-006736	anodized   technisch zilver	
	ART-006741	<b>Drop arm projection profile zwaar   Uitvalprofiel (voorslag) reinforced</b> mill finish   onbewerkt	
	ART-006742	white   wit	
	ART-006743	ivory   ivoor	
	ART-006744	anodized   technisch zilver	
<b>ARMS   ARMEN</b>			
	ART-005427	<b>Droparm   Uitvalarm</b> <b>Alu gas spring unit with alu hinge  </b> <b>Unit gasveer scharnier aluminium</b>	
	ART-005428	ivory   ivoor anodized   technisch zilver	

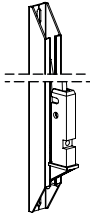



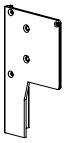
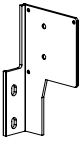
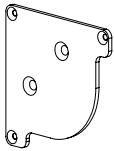

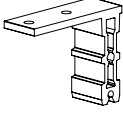

# Parts list

Onderdelenlijst

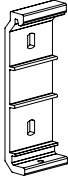
Part Onderdeel	Part No. Art.nr	Description Omschrijving	Length in m' Unit
		<b>Alu unit reinforced with nylon hinge without projection profiel  </b> <b>Unit verzaamd vast scharnier kunststof</b>	
	ART-005429	white   wit	
	ART-005430 ART-005431	ivory   ivoor anodized   technisch zilver	
5		<b>Alu unit windproof with alu hinge  </b> <b>Unit windvast scharnier aluminium</b>	
ART-005432		white   wit	
ART-005433 ART-005434		ivory   ivoor anodized   technisch zilver	
		<b>Alu unit stormproof with alu hinge standard  </b> <b>Unit stormvast scharnier aluminium standaard</b>	
	ART-005435	white   wit	
	ART-005436 ART-005437	ivory   ivoor anodized   technisch zilver	
		<b>Alu unit stormproof with alu hinge reinforced  </b> <b>Unit stormvast scharnier aluminium zwaar</b>	
	ART-005438	white   wit	
	ART-005439 ART-005440	ivory   ivoor anodized   technisch zilver	
<b>PARTS   ONDERDELEN</b>			
6		<b>End fix bracket LEFT   Kapsteun LINKS</b>	
ART-005514		mill finish   onbewerkt	
ART-005515		white   wit	
ART-005516 ART-005517		ivory   ivoor anodized   technisch zilver	
7		<b>End fix bracket RIGHT   Kapsteun RECHTS</b>	
ART-005518		mill finish   onbewerkt	
ART-005519		white   wit	
ART-005520 ART-005521		ivory   ivoor anodized   technisch zilver	
		<b>Side cover LEVIX SPECIAL  </b> <b>Zijplaat LEVIX SPECIAAL</b>	
	ART-005522	mill finish   onbewerkt	
	ART-005523	white   wit	
	ART-005524 ART-005525	ivory   ivoor anodized   technisch zilver	

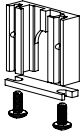

# Parts list

Onderdelenlijst

Part Onderdeel	Part No. Art.nr	Description Omschrijving	Length in m' Unit
<p>8</p> 	ART-006485	<b>Top piece   Top stuk</b> mill finish   onbewerkt	
	ART-006486	white   wit	
	ART-006487	ivory   ivoor	
	ART-006488	anodized   technisch zilver	
	ART-006489	<b>Alu corner joint for balcony arm   Aluminium hoekstuk balkonarm</b> ivory   ivoor	
	ART-006490	anodized   technisch zilver	
	ART-006510	<b>Wall bracket   Muursteun LEVIX SPECIAAL</b> mill finish   onbewerkt	
	ART-006511	white   wit	
	ART-006512	ivory   ivoor	
	ART-006513	anodized   technisch zilver	
	ART-006491	<b>Ceiling bracket   Plafondsteun</b> mill finish   onbewerkt	
	ART-006492	white   wit	
	ART-006493	ivory   ivoor	
	ART-006494	anodized   technisch zilver	
<p>9</p> 	ART-006443	<b>Mounting kit top piece   Bevestigingspakket Topstuk</b>	
	ART-006444	<b>Mounting kit top piece reinforced   Bevestigingspakket Topstuk zwaar</b>	
<p>10</p> 	ART-006481	<b>Bearing block   Lagerblok - aluminium</b> mill finish   onbewerkt	
	ART-006482	white   wit	
	ART-006483	ivory   ivoor	
	ART-006484	anodized   technisch zilver	
<p>11</p> 	ART-006457	<b>Precision bearing 32   Precisielager 32</b> staal as 15 mm	



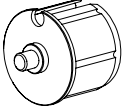
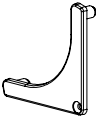
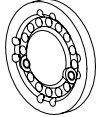
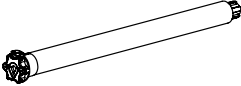

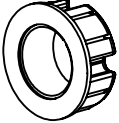
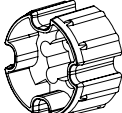
# Parts list

Onderdelenlijst

Part Onderdeel	Part No. Art.nr	Description Omschrijving	Length in m' Unit
12	 ART-006450	<b>Nylon adapter bush from 15 to 12 mm   Aanpassingsbusje 15 naar 12 mm</b>	
13	 ART-006462	<b>Nylon bearing roller bung ø63 with spindle 12 mm   Lagerprop ø63 kunststof met as 12 mm</b>	
14	 ART-005539 ART-005540 ART-005541 ART-005543	<b>Endcap front bar   Eindkapje voorlijst</b> mill finish   onbewerkt white   wit ivory   ivoor grey   grijs	
15	 ART-005409	<b>Universal bracket   Bevestigingsschijf</b>	
<b>MOTORIZED   ELEKTRISCHE BEDIENING</b>			
17		<b>Motor</b> - of your own choise - naar eigen keuze	
16		<b>Motor bracket   Motorsteun</b> - of your choise - naar eigen keuze	
18		<b>Crown   Adapter - tube   buis ø63</b> - of your choise - naar eigen keuze	
19		<b>Drive   Meenemer - tube   buis ø63</b> - of your choise - naar eigen keuze	

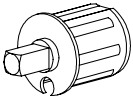

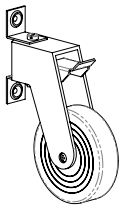
# Parts list

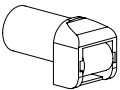
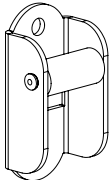
## Onderdelenlijst

Part Onderdeel	Part No. Art.nr	Description Omschrijving	Length in m' Unit
<b>MANUAL OPERATION   HANDBEDIENING</b>			
	ART-006461	<b>Nylon bearing roller bung ø48   Kunststof lagerprop ø48</b> with nylon pulley 70 mm and spindle 12 mm met kunststof schijf 70 mm en as 12 mm	
	ART-006460	<b>Nylon bearing roller bung ø48   Kunststof lagerprop ø48</b> with spindle 12 mm met as 12 mm	
	ART-006466	<b>Nylon mono plug ø48   Kunststof monoprop ø48</b> with square spindle 13 x 30 mm met vierkante as 13 x 30 mm	
	ART-006516	<b>Nylon washer   Opvulring kunststof - 20x12x2 mm</b>	
	ART-005423	<b>Cover plate inside control - tapsize M5   Afdekplaatje binnenbediening - getapt M5</b> anodized   technisch zilver	
	ART-006656	<b>Tape winder   Bandopwinder - 18 mm tape   band</b> nylon   kunststof	
	ART-000337	<b>Nylon tape guide round   Bandgeleider PVC inslag tape   band 14 mm</b> white   wit	
	ART-000335	<b>Nylon tape guide   Bandgeleider PVC insteek - nylon rol</b> white   wit	
	ART-006657	<b>Tapeguide with roller   Bandgeleider met rol for tape   voor band 18 mm</b> anodized   technisch zilver	



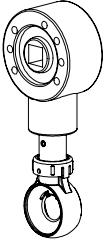
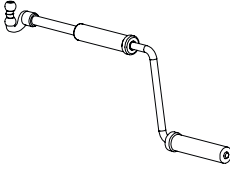
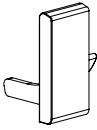
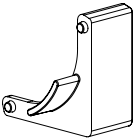

# Parts list

Onderdelenlijst

Part Onderdeel	Part No. Art.nr	Description Omschrijving	Length in m' Unit
	ART-006658	<b>Tape   Band - 18 mm</b>	50 m
	ART-000332	<b>Tape   Band - 14 mm</b> black-white   zwart-wit	
	ART-006684	<b>Gear box 1:3 with nylon eye   Oogwindwerk met PVC oog</b>	
	ART-006664	120 cm galvanized   verzinkt	
	ART-006665	120 cm white   wit	
	ART-006666	140 cm galvanized   verzinkt	
	ART-006667	140 cm white   wit	
	ART-006668	160 cm galvanized   verzinkt	
	ART-006669	160 cm white   wit	
	ART-006670	180 cm galvanized   verzinkt	
	ART-006671	180 cm white   wit	
	ART-006672	200 cm galvanized   verzinkt	
	ART-006673	200 cm white   wit	
	ART-005503	<b>Filling piece front bar LEFT   Opvulstuk voorlijst LINKS</b> mill finish   onbewerkt	
	ART-005504	white   wit	
	ART-005505	ivory   ivoor	
	ART-005506	grey   grijs	
	ART-005507	<b>Filling piece front bar RIGHT   Opvulstuk voorlijst RECHTS</b> mill finish   onbewerkt	
	ART-005508	white   wit	
	ART-005509	ivory   ivoor	
	ART-005510	grey   grijs	

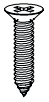
# Parts list

Onderdelenlijst

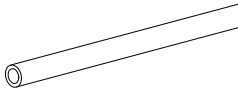
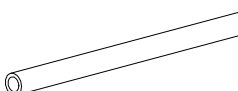
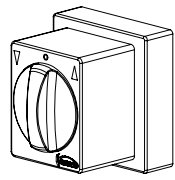
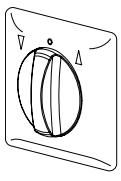
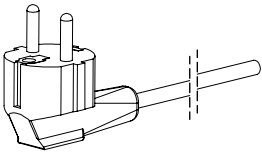
Part Onderdeel	Part No. Art.nr	Description Omschrijving	Length in m' Unit
<b>SCREWS   SCHROEVEN</b>			
20	ART-025340	<b>Self tapping screw   Zelftapper - DIN 7982 Vkkk 3.5x16</b> for mounting   montage: - End fix bracket to top cover   Kapsteun aan bovenkap - Endcap front bar   Eindkapje voorlijst	
			
21	ART-025293	<b>Metal screw   Metaalschroef - DIN 965 Pvk A2 M6x14</b> for mounting   montage: - Universal bracket   Bevestigingsschijf	
			
22	ART-025292	<b>Metal screw   Metaalschroef - DIN 965 Pvk A2 M6x10</b> for mounting   montage: - Top piece   Top stuk	
			
	ART-025363	<b>Socket-head screw with screw wrench (with cup point)   Inbus stelschroef - DIN 916 M5x10</b>	
			
	ART-025361	<b>Square nut   Vierkant moer - M5 DIN 562</b>	
			
<b>VARIOUS   OVERIGEN</b>			
	ART-005359	<b>Nylon fabric string   Doekpees kunststof - 4x6 mm</b> white   wit	
			
	ART-007658	<b>Fabric string   Doekpees - 3x5 mm</b> neoprene	
			
	ART-046677	<b>Wall-mounted rotating switch with pull relief   Opbouwschakelaar met trekontlasting</b> white   wit	
			
	ART-008871	<b>Wall-mounted rotating switch   Inbouwdraaischakelaar</b> white   wit	
			
	ART-008876	<b>Angle plug cable   Haakse stekker kabel - 3mx0,75</b>	3 mtr
			



# Parts list

Onderdelenlijst

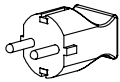
Part Onderdeel	Part No. Art.nr	Description Omschrijving	Length in m' Unit
	ART-008875	<b>Earth connection plug   Klapstekker met rand- en penaarde</b>	





**BOLBYR®**

Bolbyr B.V. - Magazijnweg 27-29 - 5683 CV Best - Nederland (Netherlands)  
T +31 (0)88-9876543 - sales@bolbyr.com - www.bolbyr.com